

# TM 11-6130-250-15

DEPARTMENT OF THE ARMY TECHNICAL MANUAL

---

**OPERATOR,  
ORGANIZATIONAL, DS, GS,  
AND DEPOT MAINTENANCE  
MANUAL**

**CHARGER, BATTERY  
PP-4127/U**

---

This copy is reprint which includes current pages from Changes 1 through 3.

HEADQUARTERS, DEPARTMENT OF THE ARMY

JUNE 1967

## **WARNING**

High voltages and currents exist in this equipment. Serious injury or death may result from contact with the output terminals. Deenergize the equipment before connecting or disconnecting the battery to be charged, and before performing any maintenance.

**DO NOT TAKE CHANCES!**

## **WARNING**

### **DANGEROUS CHEMICALS ARE USED IN NICKEL-CADMIUM BATTERIES**

The electrolyte used in nickel-cadmium batteries contains potassium hydroxide (KOH), which is a caustic chemical agent. Serious and deep burns of body tissue will result if the electrolyte comes in contact with the eyes or any part of the body. Use rubber gloves, rubber apron, and protective goggles when handling the electrolyte. If accidental contact with the electrolyte is made, use ON clean water and immediately (seconds count) flush contaminated areas. Continue flushing with large quantities of clean water for at least 15 minutes. Seek medical attention without delay.

### **EXPLOSIVE GASES ARE GENERATED BY NICKEL-CADMIUM BATTERIES**

Hydrogen and oxygen gases are generated in explosive proportions while the nickel-cadmium battery is being charged. Charge the nickel-cadmium battery in a well-ventilated area to reduce concentrations of explosive gases. Turn off the battery charger before connecting or disconnecting the nickel-cadmium battery to prevent arcing. Do not use matches or an open flame in the charging area. Arcs, flames, or sparks in the charging area will ignite the gases and cause an explosion. The batt box cover must be removed and the battery case vent plug (if used) must be open when charging.

### **DO NOT MIX SULPHURIC ACID AND KOH**

The electrolyte used in nickel-cadmium batteries reacts violently to the sulphuric acid used in the more common lead-acid types of batteries. DO NOT add sulphuric acid electrolyte to the battery; the mixing of the acid and KOH electrolytes will cause a violent reaction which could result in the splattering of the mixture into the eyes and onto the skin.

Every effort must be made to keep nickel-cadmium batteries as far away as possible from lead-acid batteries. Do not use the same tools and materials such as screwdrivers, wrenches, syringes, hydrometers, and gloves for both types of batteries. Any trace of acid or acid fumes will permanently damage nickel-cadmium batteries on contact.

**CHANGE** }  
**No. 3** }

HEADQUARTERS  
 DEPARTMENT OF THE ARMY  
 WASHINGTON, DC, 13 May 1982

**Operator, Organizational, Direct Support, General Support,  
 and Depot Maintenance Manual**

**CHARGER, BATTERY PP-4127/U (NSN 6130-00-928-1942)**

**PP-4127A/U (NSN 6130-00-782-6893) and PP-4127B/U**

TM 11-6130-250-15, 25 June 1967, is changed as follows:

1. Title of manual is changed as shown above.
2. New or changed material is indicated by a vertical bar in the margin of the page.
3. Remove and insert pages as indicated below.

Remove	Insert
None.....	a and b
1-1 and 1-2 .....	1-1 and 1-2
3-3 and 3-4 .....	3-3 and 3-4
5-1 and 5-2 .....	5-1 and 5-2
6-3 through 6-6 .....	6-3 through 6-6
7-1 and 7-2 .....	7-1 and 7-2
7-9 and 7-10 .....	7-9 and 7-10
7-11 .....	.None
8-1 .....	8-1
A-1 .....	A-1
C-1 through C-3 .....	C-1 through C-5/(C-6 blank)
I-1 and I-2 .....	Index-1 and Index-2

3. File this change sheet in front of the publication for reference purposes.

By order of the Secretary of the Army:

Official:  
 ROBERT M. JOYCE  
*Brigadier General United States Army*  
*The Adjutant General*

E. C. MEYER  
*General, United States Army*  
*Chief of Staff*

**DISTRIBUTION:**

To be distributed in accordance with DA Form 12-34B, Requirements for TMDE/Calibration and Repair.

CHANGE }  
No. 2 }

HEADQUARTERS  
DEPARTMENT OF THE ARMY  
WASHINGTON, DC, 23 April 1975

**Operator, Organizational, Direct Support, General Support,  
and Depot Maintenance Manual  
CHARGER, BATTERY PP-4127/U**

TM 11-6130-250-15, 25 June 1967, is changed as follows:

1. A vertical bar appears opposite changed material.
2. Remove and insert information as indicated below:

*Remove*

None

*Insert*

Add warning notice inside front cover to existing  
warning

3. File this change sheet in the front of the manual for reference purposes.

By Order of the Secretary of the Army:

FRED C. WEYAND  
*General, United States Army*  
*Chief of Staff*

Official:

VERNE L. BOWERS  
*Major General, United States Army*  
*The Adjutant General*

Distribution:

*Active Army:*

USASA (S)	USAINTCS (3)
Dir of Trans (1)	USAADS (2)
COE (1)	USAFAS (2)
TSG (1)	USAARMS (2)
USAARENBD (1)	USAIS (2)
AMC (1)	USAES (2)
MICOM (2)	AD (1) except
TECOM (2)	SAAD (30)
TRADOC (2)	LBAD (14)
ARADCOM (2)	TOAD (14)
ARADCOM Rgn (2)	USA Dep (2)
OS Maj Comd (4)	Sig Sec USA Dep (2)
LOGCOMD (3)	Sig Dep (2)
USACC (4)	ATS (1)
MDW (1)	MAAG (1)
Armies (2)	WRAMC (1)
Corps (2)	USAERDAA (1)
HISA (Ft Monmouth) (43)	USAERDAW (1)
Svc Colleges (1)	USARMIS (1)
USASESS (5)	Units org under fol TOE:- 1 ea.
Ft Gordon (10)	7-16
Ft Huachuca (10)	7-46
Ft Gillem (10)	29-15
Ft Carson (5)	29-35
WSMR (1)	29-134
USASESS (5)	29-136

*ARNG*: State AG (3).

*USAR*: None

For explanation of abbreviations used, see AR 310-50.

CHANGE }  
No. 1 }

HEADQUARTERS  
DEPARTMENT OF THE ARMY  
WASHINGTON, DC, 10 May 1974

**Operator, Organizational, Direct Support, General Support  
and Depot Maintenance Manual  
CHARGER, BATTERY PP-4127/U**

TM 11-6130-250-15, 25 June 1967, is changed as follows:

- 1. A vertical bar appears opposite changed material.
- 2. Remove and insert pages as indicated in the page list below:

<i>Remove</i>	<i>Insert</i>
i and ii .....	i and ii
1-1 and 1-2 .....	1-1 and 1-2
2-1 and 2-2 .....	2-1 and 2-2
B-1 and B-2 .....	None

- 3. File this change sheet in the front of the manual for reference purposes.

By Order of the Secretary of the Army:

**CREIGHTON W. ABRAMS**  
*General, United States Army*  
*Chief of Staff*

Official:

**VERNE L. BOWERS**  
*Major General, United States Army*  
*The Adjutant General*

Distribution:

*Active Army:*

- |                 |                       |                              |
|-----------------|-----------------------|------------------------------|
| CNGB (1)        | USACC (2)             | LBAD (10)                    |
| TSG (1)         | HISA Ft Monmouth (18) | SAAD (30)                    |
| ACSC-E (2)      | Armies (1)            | TOAD (14)                    |
| USAMB (10)      | USAINTC (15)          | ATAD (10)                    |
| USAAARENBD (1)  | USASCS (10)           | USA Dep (1)                  |
| USASA (2)       | USASESS (5)           | Sig Sec USA Dep (2)          |
| TRADOC (2)      | Svc Colleges (5)      | Sig Dep (2)                  |
| AMC (1)         | Fort Huachuca (5)     | Sig FLDMS (1)                |
| MICOM (1)       | WSMR (1)              | Ft Richardson (ECOM Ofc) (1) |
| TECOM (2)       | Fort Carson (5)       | Units org under fol TOE:     |
| ARADCOM (2)     | USAERDAA (1)          | (1 copy each)                |
| ARADCOM Rgn (1) | USAERDAW (1)          | 11-158                       |
| OS Maj Comd (2) | Army Dep (1) except   | 29-134                       |
|                 |                       | 29-136                       |

NG: State AG (3)

USAR: None

For explanation of abbreviations used, see AR 310-50.



**5**

**SAFETY STEPS TO FOLLOW IF SOMEONE IS THE VICTIM OF ELECTRICAL SHOCK**

**1**

**DO NOT TRY TO PULL OR GRAB THE INDIVIDUAL**

**2**

**IF POSSIBLE, TURN OFF THE ELECTRICAL POWER**

**3**

**IF YOU CANNOT TURN OFF THE ELECTRICAL POWER, PULL, PUSH, OR LIFT THE PERSON TO SAFETY USING A WOODEN POLE OR A ROPE OR SOME OTHER INSULATING MATERIAL**

**4**

**SEND FOR HELP AS SOON AS POSSIBLE**

**5**

**AFTER THE INJURED PERSON IS FREE OF CONTACT WITH THE SOURCE OF ELECTRICAL SHOCK, MOVE THE PERSON A SHORT DISTANCE AWAY AND IMMEDIATELY START ARTIFICIAL RESUSCITATION**

## **WARNING**

To prevent personal injury when applying or removing steel strapping from crates or cartons, wear heavy gloves and protective eyeglasses. Do not handle cartons or crates by the steel straps.

## **WARNING**

### **CLEANING WITH COMPRESSED AIR**

Compressed air shall not be used for cleaning purposes except where reduced to less than 29 pounds per square inch (psi) and then only with effective chip guarding and personnel protective equipment. Do not use compressed air to dry parts when TRICHLOROTRIFLUOROETHANE has been used.

Compressed air is dangerous and can cause serious bodily harm if protective means or methods are not observed to prevent chip or particle (of whatever size) from being blown into the eyes or unbroken skin of the operator or other personnel.

## **WARNING**

Adequate ventilation should be provided while using TRICHLOROTRIFLUOROETHANE. Prolonged breathing of the vapor should be avoided. The solvent should not be used near heat or open flame the products of decomposition are toxic and irritating. Since TRICHLOROTRIFLUOROETHANE dissolves natural oils, prolonged contact with skin should be avoided. When necessary, use gloves which the solvent cannot penetrate. If the solvent is taken internally, consult a physician immediately.



**Operator, Organizational, Direct Support General Support  
and Depot Maintenance Manual**

**CHARGER, BATTERY PP-4127/U**

	Paragraph	Page
CHAPTER 1.	INTRODUCTION	
Section I.	General . . . . .	1-1-1-3 1-1
II.	Description and data . . . . .	1-4-1-6 1-1-1-2
CHAPTER 2.	INSTALLATION AND OPERATING INSTRUCTIONS	
Section I.	Service upon receipt of equipment . . . . .	2-1,2-2 2-1
II.	Operator's controls and indicators . . . . .	2-3-2-7 2-2-2-6
III.	Operating procedures . . . . .	2-8, 2-9 2-6,2-7
CHAPTER 3.	OPERATOR AND ORGANIZATIONAL MAINTENANCE . . . . .	3-1- 3-12 3-1-3-4
CHAPTER 4.	FUNCTIONING OF EQUIPMENT	
Section I.	Battery charging circuitry . . . . .	4-1,4-2 4-1,4-3
II.	Battery discharger circuitry . . . . .	4-3, 4-4 4-6
CHAPTER 5.	TROUBLESHOOTING	
Section I.	General troubleshooting techniques . . . . .	5-1-5-3 5-1-5-2
II.	Troubleshooting battery charger circuitry . . . . .	5-1-5-9 5-8-5-11
III.	Troubleshooting battery discharger circuitry . . . . .	5-10-5-13 5-14
CHAPTER 6.	REPAIRS AND ADJUSTMENTS.	
Section I.	Repairs . . . . .	6-1-6-6 6-1-6-3
II.	Adjustments . . . . .	6-7-6-9 6-3-6-5
CHAPTER 7.	GENERAL SUPPORT TESTING PROCEDURES . . . . .	7-1-7-8 7-1-7-11
8.	DEPOT OVERHAUL STANDARDS . . . . .	8-1-8-4 8-1
9.	SHIPMENT, LIMITED STORAGE, AND DEMOLITION TO PREVENT ENEMY USE . . . . .	9-1-9-3 9-1
APPENDIX A.	REFERENCES . . . . .	A-1
B.	BASIS ISSUE ITEMS LIST (BILL) AND ITEMS TROOP INSTALLED OR AUTHORIZED LIST (ITIAL) (Not Applicable)	
APPENDIX C.	MAINTENANCE ALLOCATION . . . . .	C-1
INDEX	. . . . .	I-1

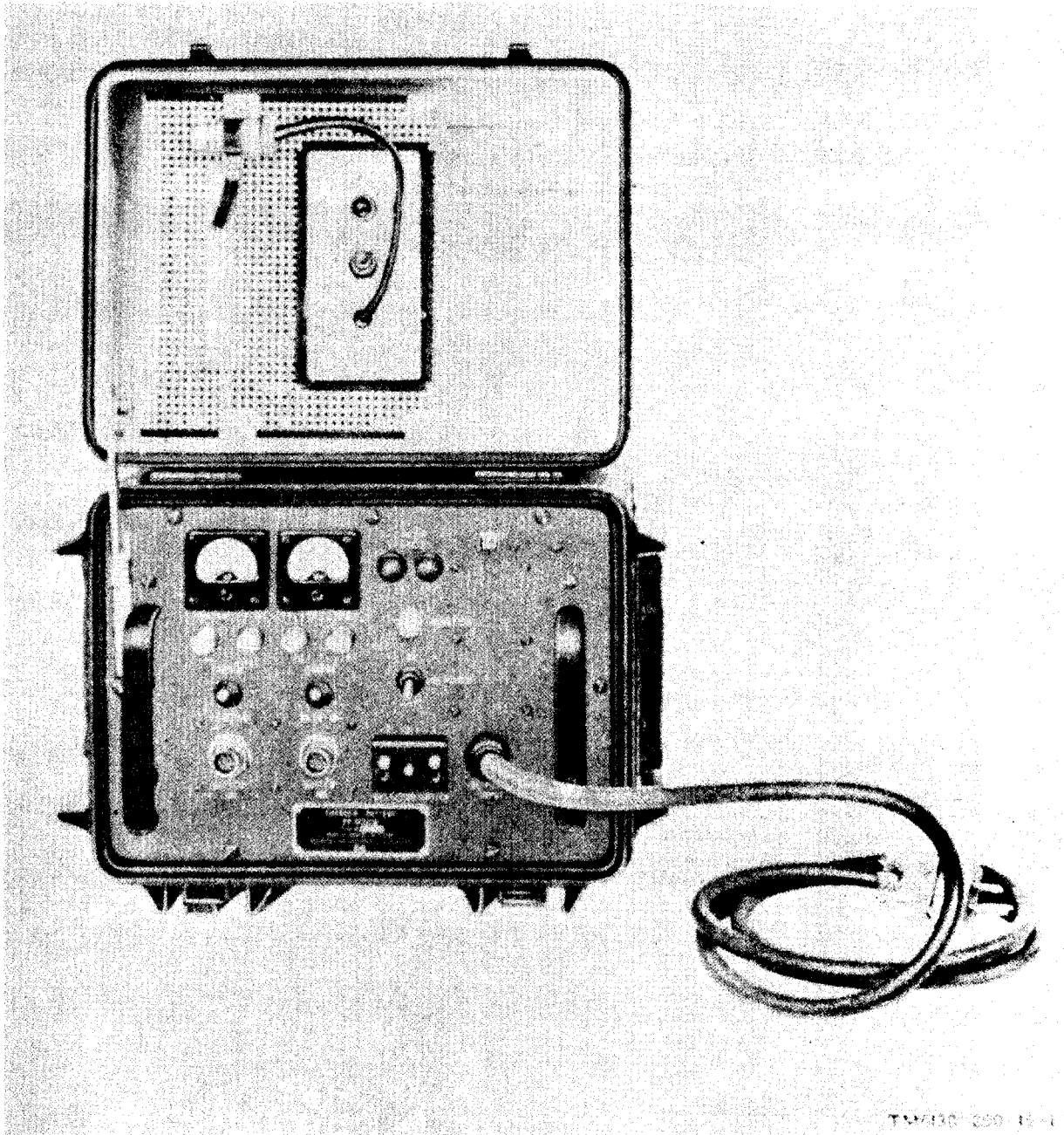

Figure 1-1. Charger, Battery PP-4127/U, cover open.

# CHAPTER 1

## INTRODUCTION

### Section I. GENERAL

#### 1-1. Scope

This manual describes Charger, Battery PP-4127/U (fig. 1-1) and provides instructions for its installation, operation, and organizational, direct support, general support, and depot maintenance. It contains instructions for operating, cleaning, and inspecting the equipment, and for replacing parts. A functional analysis of the equipment is also given. Charger, Battery PP-4127/U consists of a battery charger unit and a battery discharger unit. In this manual, Charger, Battery PP-4127/U, as a complete unit, is referred to as the PP-4127/U. When a reference is made to the portion of the PP-4127/U that is used to charge batteries, the common name *battery charger* is used. When a reference is made to the portion of the PP-4127/U that is used to discharge batteries, the common name *battery discharger* is used.

#### NOTE

References to the PP-4127/U in this manual include models PP-4127A/U and PP-4127B/U.

#### 1-2. Index of Technical Publications

Refer to the latest issue of DA Pam 310-4 to determine whether there are new editions, changes, additional publications, or modification work orders pertaining to the equipment.

#### 1-3. Maintenance Forms, Records and Reports

*a. Reports of Maintenance and Unsatisfactory Equipment.* Department of the Army forms and procedures used for equipment maintenance will be those prescribed by TM 38-750, The Army Maintenance Management system.

*b. Report of Packaging and Handling Deficiencies.* Fill out and forward SF 364 (Report of Discrepancy (ROD)) as prescribed in AR 735-11-2/DLAR 4140.55/NAVMATINST 4355.73/AFR400-54/MCO4430.3E.

*c. Discrepancy in Shipment Report (DISREP) (SF 361).* Fill out and forward Discrepancy in Shipment Report (DISREP) (SF 361) as prescribed in AR 55-38/NAVSUPINST 4610.33B/AFR 75-18/MCO P4610.19C/DLAR 4500.15.

#### 1-3.1. Reporting Errors and Recommending Improvement

You can help improve this manual. If you find any mistakes or if you know of a way to improve the procedures, please let us know. Mail your letter or DA Form 2028 (Recommended Changes to Publications and Blank Forms) direct to Commander, US Army Communications-Electronics Command, ATTN: DRSEL-ME-MQ, Fort Monmouth, NJ 07703. In either case, a reply will be furnished direct to you.

### Section II. DESCRIPTION AND DATA

#### 1-4 Purpose and Use

(figs. 1-1 and 1-2)

*a.* The battery charger circuitry of the PP-4127/U converts 115-volt or 230-volt alternating current (ac) at 60 or 400 cycles per second (cps) to 6 amperes of constant direct current for charging one or two secondary silver-zinc batteries (Battery, Storage BB-622/U (battery) contained in Battery Box CY-3871/PPS-5). The battery charger includes an automatic voltage-sensing and cutoff circuit for each battery being charged. When each battery is fully charged, the voltage-sensing-and cutoff circuit

automatically removes the charging current from the battery. Indicator lights on the front panel provide visual indications of the charging operations, and meters mounted on the front panel provide indications of the charging current supplied to each battery being charged. The battery charger circuitry is completely independent of the battery discharger circuitry; therefore, charging and discharging operations can be simultaneously performed.

#### CAUTION

Use the battery discharger *only* when

instructed to do on in the maintenance procedures for the battery to be serviced.

b. The battery discharger circuitry of the PP-4127/U is mounted in the cover of the transit case, and discharges a BB-622/U-type battery to a level of  $4.2 \pm 0.1$  volts. The operating voltage for this circuitry is obtained from the battery being discharged. When the potential of the battery being discharged reaches  $4.2 \pm 0.1$  volts, the discharging is automatically stopped. A switch, to initiate the discharging operation, and an indicator light, that remains on when discharging is taking place, are provided on the battery discharger control panel. The battery discharger can be used to deep discharge batteries; the use of the battery discharger prevents the batteries from being discharged below the level where polarity reversal of the battery might occur.

**1-5. Technical Characteristics**

- Input power:**
  - Voltage..... 115 or 230 volts  $\pm 10$  percent; 60 or 400 c o p s 5 percent.
  - Phase..... Single.
  - Current (maximum). . . . . 2.0 amperes (full load 115 volts ac), or 1.3 ampere (full load, 230 volts ac).
  - Power consumption. . . . . Full load, two batteries being charged: approximately 220 watts maximum.
- Battery charger output power for each battery being charged:**
  - Voltage..... To  $8.1 \pm 0.1$  volts, then cuts off.
  - Current..... 6.00 to  $\pm 0.48$  amperes dc.
- Battery discharger:**
  - Input voltage (maximum)..... 8 volts direct current from battery being discharged.

- Discharge current ..... 10 amperes (approximate).
- Cutoff voltage .....  $4.2 \pm 0.1$  volts dc.
- Weight ..... 35 pounds.
- Ambient operating temperature range** .....  $-40^{\circ}\text{F}$  ( $-40^{\circ}\text{C}$ ) to  $+125^{\circ}\text{F}$  ( $+51.5^{\circ}\text{C}$ ).

**1-6. Description of Equipment**

(figs. 1-1 and 1-2).

The PP-4127/U is a self-contained, portable unit housed in a metal, waterproofed, hermetically sealed transit case. A pressure relief valve at the center of the front of the transit case prevents any excessive pressure buildup inside the transit case during submersion. The dimensions of the transit case are  $13\frac{3}{4}$  inches wide,  $12\frac{7}{8}$  inches high, and 10 inches deep. Operating controls and indicators for the battery charger are mounted on the front panel. Two carrying handles are also located on the front panel. The hinged cover of the transit case houses the battery discharger and stores the 8-foot long input power cable for the battery charger. The power cable is terminated in a heavy-duty, three-wire, connector plug. All the spare parts for the PP-4127/U are included in the field maintenance kit for Radar Set AN/PPS-5.

**1-7. Item Comprising an Operable Charger, Battery PP-4127/U**

Charger, Battery PP-4127/U (FSN 6130-928-1942) comprises an operable equipment and is shown in figure 1-1.

**1-8. Model Differences**

Models PP-4127A/U and PP-4127B/U are two-way interchangeable except by maintenance parts with PP-4127/U. The PP-4127B/U has four filters and a filter enclosure not found on PP-4127/U and PP-4127A/U.

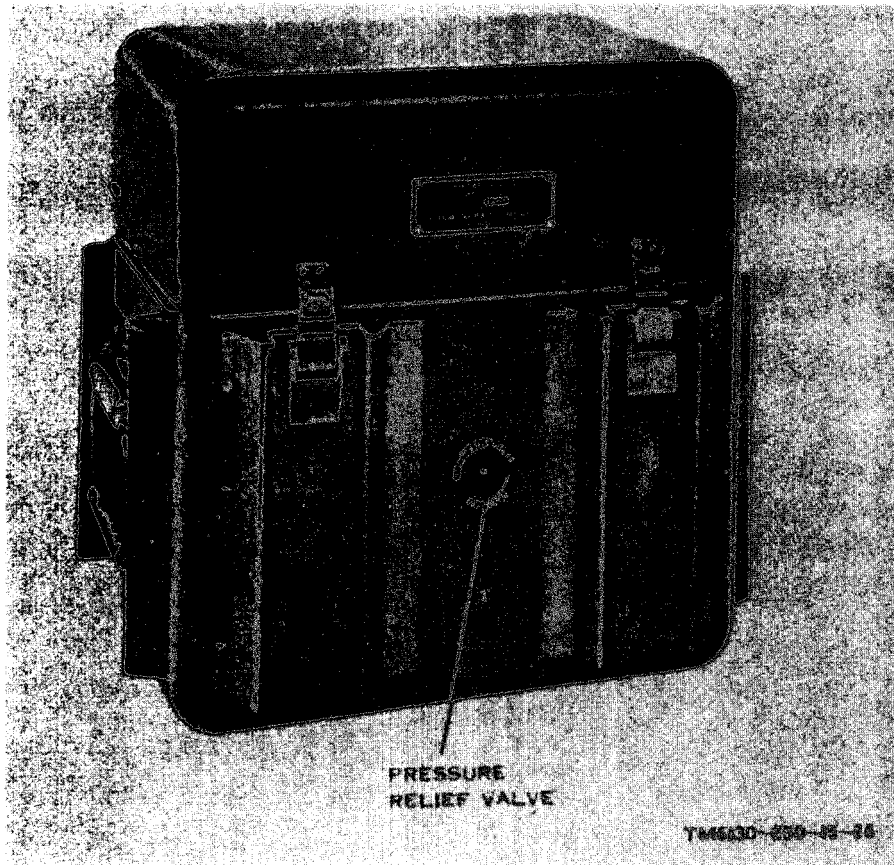

Figure 1-2. Charger, Battery PP-4127/U, cover closed.



## CHAPTER 2 INSTALLATION AND OPERATING INSTRUCTIONS

---

### Section I. SERVICE UPON RECEIPT OF EQUIPMENT

#### 2-1. Upacking

a. *Packaging Data.* The method of packaging the PP-4127/U for shipment is shown in figure 2-1. Dimensions and volume of the shipping cartons are given in the chart below.

Carton	Dimensions (in.)	Volume (cu ft)
Interior .....	14½ x 13 x 10½	1.07
Exterior .....	15 x 13½ x 11	1.29

#### b. *Removing Contents.*

(1) Slit the tape that seals the exterior carton; be careful not to damage the technical manual, which is located directly below the top flaps.

(2) Open the flaps and remove the waterproof envelope that contains the technical manual.

(3) Remove the waterproof barrier bag from the exterior carton and open it.

(4) Remove the interior carton from the waterproof barrier bag and carefully open it. Be careful not to scratch or damage the surfaces of the equipment during this procedure.

(5) Remove the equipment.

#### 2-2. Checking Unpacked Equipment

a. Inspect the equipment for damage incurred during shipment. If the equipment has been damaged report the damage on DD Form 6.

b. Check to see that the equipment is complete as listed on the packing slip. Report all discrepancies in accordance with procedures given in TM 38-750. Shortage of a minor assembly or part that does not affect proper functioning of the equipment should not prevent use of the equipment.

c. If the equipment has been used or reconditioned, check to see whether it has been changed by a modification work order (MWO). If the equipment has been modified, the MWO number will appear on the front panel near the nomenclature plate. If the equipment has been modified, check to see that any operational instruction changes which result from the modification have been entered in the equipment manual.

#### NOTE

Current MWO's applicable to the equipment are listed in DA Pam 310-4.

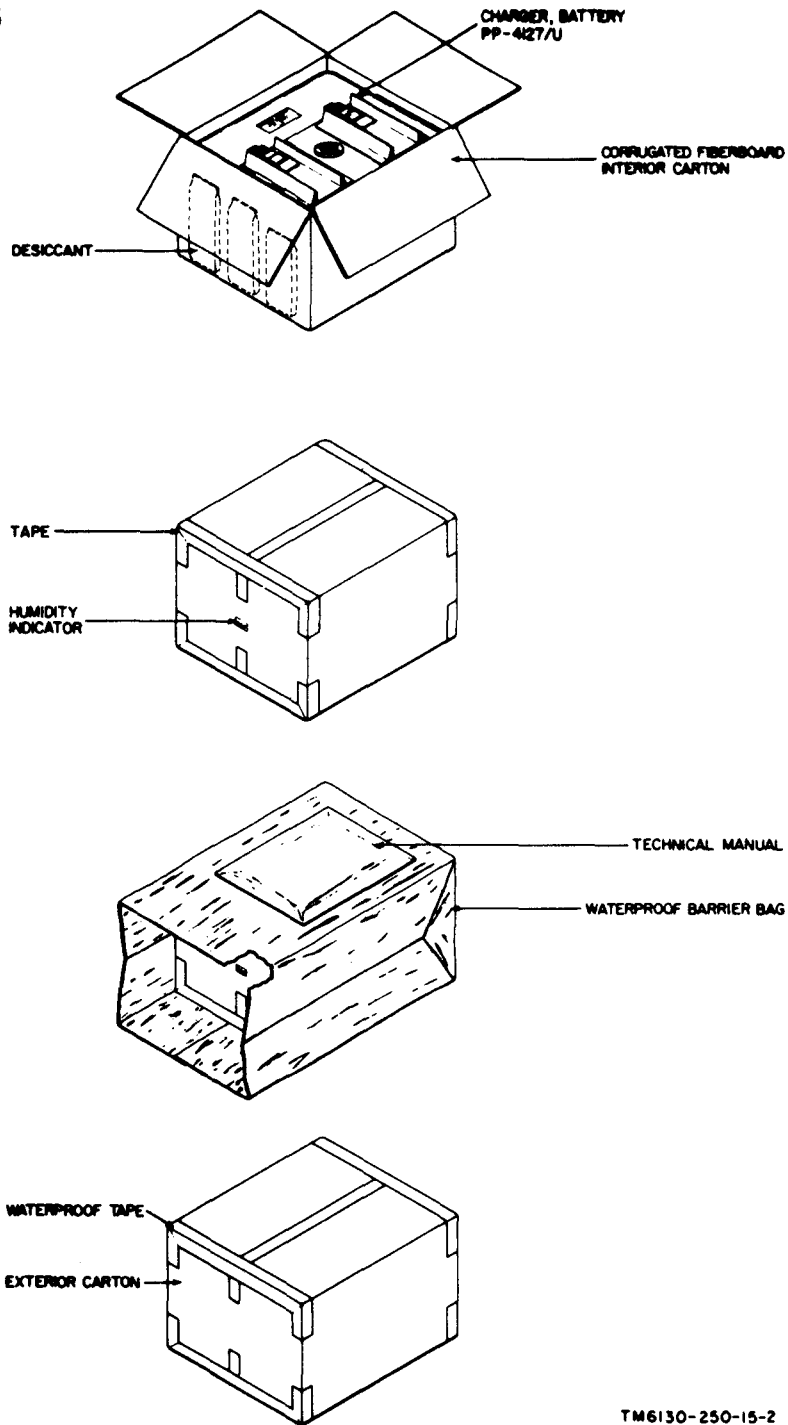

Figure 2-1. Typical packaging.

## Section II. OPERATOR'S CONTROLS AND INDICATORS

### 2-3. Damage from Improper Settings

a. Before operating the battery charger, be sure that the SELECTOR SWITCH is set to the correct

input ac supply voltage position (115 V visible above the switch guard for 115-volt ac operation, or 230 V visible below

\*U.S. GOVERNMENT PRINTING OFFICE: 1974-768117/1587



the switch guard for 230-volt ac operation). Failure to set the SELECTOR SWITCH to the appropriate voltage setting will result in equipment damage when power is turned on.

b. If a portable generator set is used to supply the operating voltage for the battery charger, damage to the battery charger circuitry may result if the input voltage and frequency are not within the required ranges

(para 1-5). The output voltage and frequency of the generator set should be checked and, if necessary, adjusted before the battery charger is connected to the power source.

2-4. Battery Charger Controls and Indicators

(fig. 2-2)

Control, indicator, connector, or circuit breaker	Function
SELECTOR SWITCH -----	Connects internal circuitry of battery charger for 115-vac operation (when switch guard is set to expose 115 V), or for 230-vac operation (when switch guard is set to expose <sup>to expose</sup> 230 V). <sub>V</sub> .
AC POWER switch -----	Connects 115-volt or 230-volt ac power to battery charger when when set to ON; disconnects ac power when <del>set to</del> OFF.
POWER ON indicator light -----	indicator indicator light illuminates when battery charger is energized.
TEST METER (A) -----	Indicates amount of charging current to battery con- nected to BATTERY (A) connector.
CHARGE ON and OFF indicator lights, located beneath TEST METER (A).	ON light illuminates (green) to indicate current flow through BATTERY (A) connector. OFF light illuminates (blue) when current is not flowing through BATTERY (A) connector.
RESET (A) switch -----	Two-position switch, spring-loaded to off (up) position. When momentarily held in the down position, permits charging current to flow and energize battery A charging control circuit. Also, when momentarily held down, shorts out TEST METER (A) to prevent any damage to meter that might be caused by current surges. When switch is released, TEST METER (A) indicates charging current.
BATTERY (A) connector -----	Provides connection to battery for charging.
TEST METER (B) -----	Indicates amount of charging current to battery con- nected to BATTERY (A) connector.
CHARGE ON and OFF indicator lights, located beneath TEST METER (B).	ON light illuminates (green) to indicate current flow through BATTERY (B) connector. OFF light illuminates (blue) when no current is flowing through BATTERY (B) connector.
RESET (B) switch -----	Two-position switch, spring-loaded to off (up) position. When momentarily held in the down position, permits charging current to flow and energize battery battery B charging control circuit. Also, when momentarily held down, shorts out TEST METER (B) to prevent any damage to meter that might be caused by current surges. When switch is released, TEST METER (B) indicates charging current.
BATTERY (B) connector -----	Provides connection to battery for charging.
CIRCUIT BREAKERS -----	Disconnect primary input power from battery charger when current exceeds 1 1/2 ampere. When momentarily held in the down position, resets circuit breaker to on.
AC POWER INPUT cable and connector.	Connects battery charger to primary input power source.

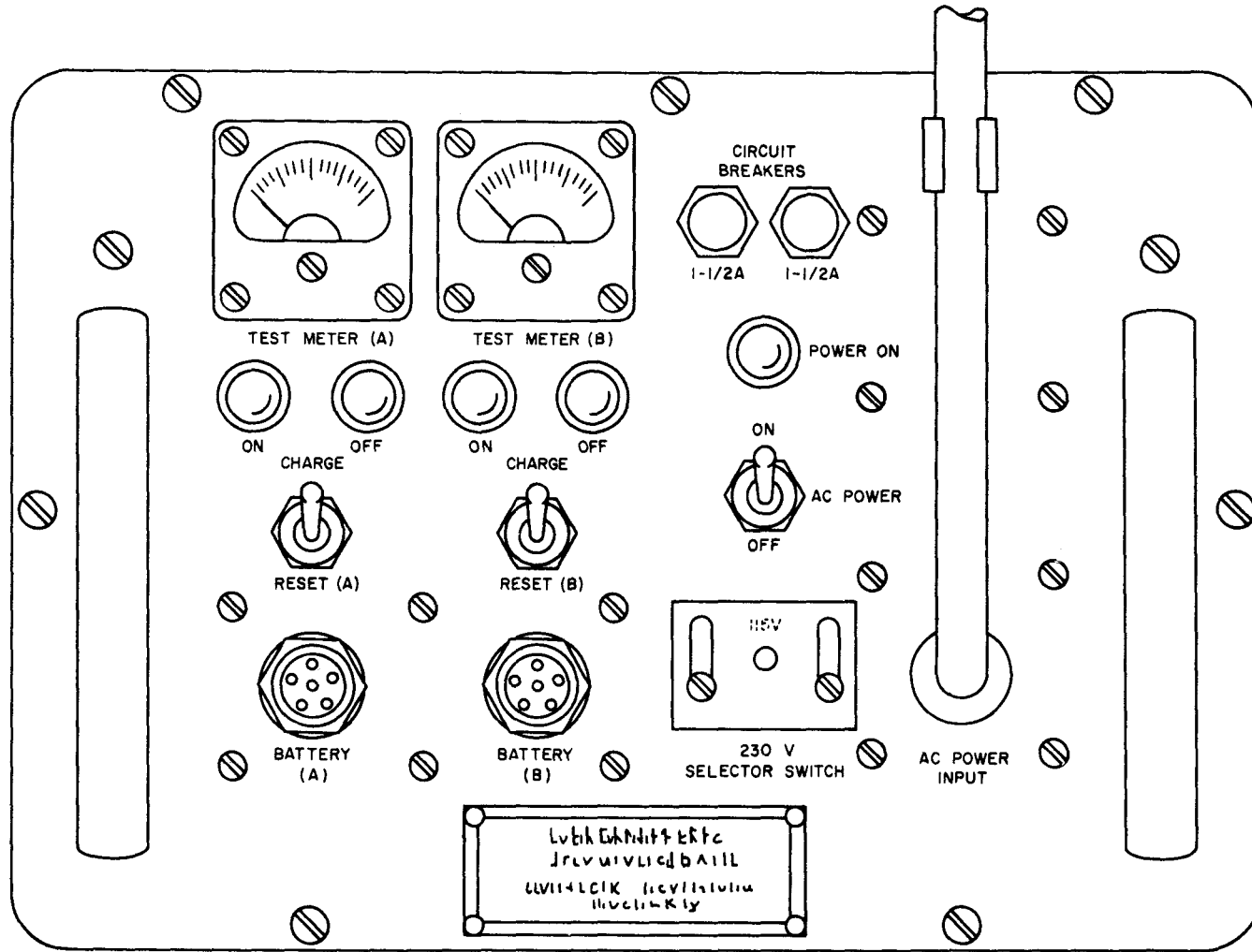

TM6130-250-15-3

Figure 2-2. Battery charger controls and indicators.

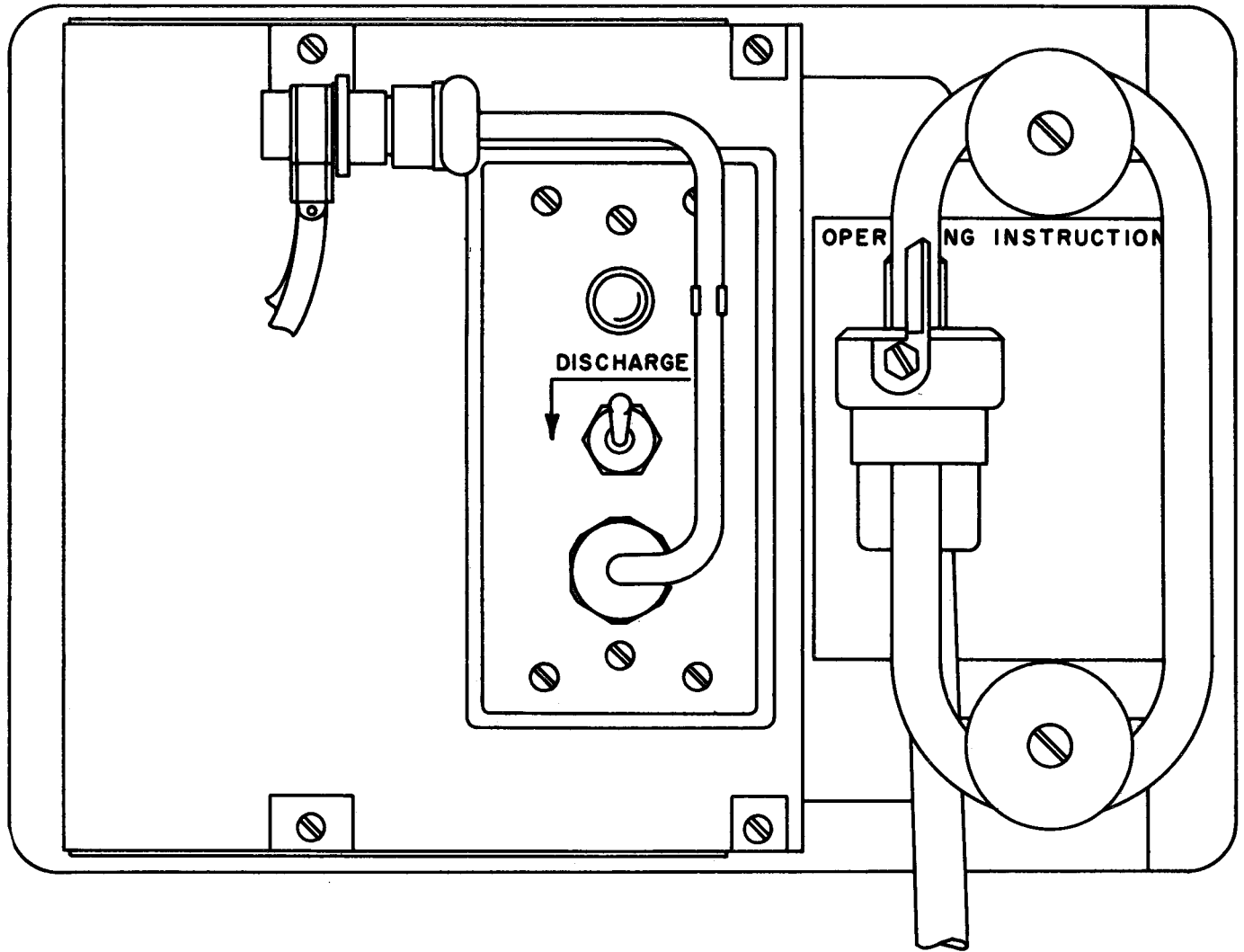

TM6130-250-15-4

Figure 2-3. Battery discharger, controls and indicators.

2-5. Battery Discharger Operating Control and Indicator (fig. 2-3)

Control, connector, or indicator	Function
DISCHARGE switch.	When depressed, connects battery voltage to battery discharger circuitry to initiate battery discharging operation.
DISCHARGE indicator light.	Indicator light illuminates (red) to indicate battery discharging is taking place. Extinguishes when battery is discharged to a level of $4.2 \pm 0.1$ volts.
Battery discharger cable and connector.	Use to connect battery to battery discharger.

2-6. Selector Switch (fig. 2-2)

Two screws lock the SELECTOR SWITCH in either the 115 V or the 230 V position.

Loosen the two screws to set the SELECTOR SWITCH in the up position for 230-volt operation or in the down position for 115-volt operation. Tighten the screws to lock the switch in position. In the up position, 230 V will be visible; in the down position, 115 V will be visible.

2-7. Voltage-Sensing Cutoff

When the battery charging voltage reaches  $8.1 \pm 0.1$  volts, the voltage-sensing circuit will automatically cut off the charging current to the battery. The voltage sensing circuit is sensitive enough to cut off the charging current for a momentary, transient voltage as initial turn-on occurs. If a battery is known to require charging, and the voltage-sensing circuit cuts off the current to that battery, depress the associated RESET (A) or RESET (B) switch to restore the charging current.

Section III. OPERATING PROCEDURES

2-8. Battery Charging Procedures

a. Starting Procedure.

- (1) Release the cover latches, and open the cover of the PP-4127/U. Figure 1-1 (cover open) shows the PP-4127/U in its normal operating position for charging batteries.
- (2) Set the AC POWER switch to OFF.
- (3) Loosen the screws that lock the SELECTOR SWITCH switch guard to the position which corresponds to the selected input power. (Push the switch guard down for 115-volt operation, or up for 230-volt operation.) Tighten the switch guard screws to lock the SELECTOR SWITCH in the selected position.
- (4) Connect the AC POWER INPUT cable connector to the input power source receptacle.
- (5) If two batteries are to be charged, connect cables of batteries to be charged to the BATTERY (A) and BATTERY (B) connectors. If only one battery is to be charged, connect the cable from the battery to be

charged to the BATTERY (A) or BATTERY (B) connector, and use the corresponding controls and indicators.

b. Charging Operating Procedures,

*Note.* This procedure describes the charging of one battery that is connected to the BATTERY (A) connector. The procedure is identical with a battery connected to the BATTERY (B) connector, except that BATTERY (B) controls and indicators are used.

- (1) Set the AC POWER switch to ON, and check to see that the POWER ON indicator light and the CHARGE OFF indicator light beneath TEST METER (A) illuminate.
- (2) Push the RESET (A) switch down and hold it depressed for about 4 seconds to start the battery charging. Check to see that the battery A CHARGE ON indicator light illuminates, and that TEST METER (A) indicates 6 amperes. The battery is now being charged at 6 amperes. The battery will continue to

be charged at 6 amperes until the battery charging voltage reaches  $8.1 \pm 0.1$  volts. If the voltage-sensing circuit cuts off the battery-charging current immediately after release of the RESET (A) switch depress the RESET (A) switch again and hold it down for 4 seconds, or more. If the battery-charging current is again cut off, the battery is at full charge and the battery charger will not provide any additional charge.

- (3) When the battery is fully charged, the battery A CHARGE OFF indicator light will illuminate as the CHARGE ON indicator light extinguishes; TEST METER (A) will also indicate zero ampere at this time.

**Note.** If the battery charger and the input power source are left unattended for long periods of time and the input power source fails, the green CHARGE ON indicator lights will be out. When power is restored, the blue CHARGE OFF indicator lights will be on, indicating that batteries are fully charged when they actually are not. Press the RESET (A) (B) switches and hold them down for 4 seconds, or more. If the blue CHARGE OFF indicator lights illuminate when the RESET (A) and RESET (B) switches are released, batteries are fully charged. If the green CHARGE ON indicator lights illuminate, batteries require more charging. Continue the charging process until the charging current automatically cuts off.

*Stopping Procedure.*

- (1) Set the AC POWER switch to OFF.
- (2) Disconnect the cable connector of the battery being charged from the battery charger.
- (3) Disconnect the AC POWER INPUT cable connector plug from the input power source receptacle and secure the cable and connector in the cover of the PP-4127/U.
- (4) Close and latch the cover of the PP-4127/U.

## 2-9. Battery Discharging Procedures

**Caution:** Use the battery discharger *only* when instructed to do so in the maintenance procedures for the battery to be serviced. Battery, Storage BB-622/U should not be discharged below a 4-volt level. Polarity reversal of the BB-622/U may result when it is recharged after being discharged below the 4-volt level.

a. Open the cover of the PP-4127/U and uncoil the battery charger AC POWER INPUT cable and connector from its retaining brackets in the cover. Leave the AC POWER INPUT cable and connector out of the cover so that the heat generated during discharging operations will not damage the cable. The battery discharger is completely independent of the battery charger. (The AC POWER INPUT cable may or may not be connected to a power source, as required.)

b. Place the PP-4127/U so that the battery charger front panel and the battery discharger control panel are facing the front.

c. Connect the cable of the battery discharger to the cable of the battery to be discharged.

**Caution:** Do not close the cover of the PP-4127/U during battery discharging operations. The open cover helps to dissipate the heat generated during discharging operations

d. Depress the DISCHARGE switch and release it. Check to see that the red DISCHARGE indicator light illuminates to indicate that the battery is being discharged.

e. When the battery potential reaches  $4.2 \pm 0.1$  volts, the battery discharger will automatically disconnect the battery from the battery discharger circuitry. This condition will be indicated by the red DISCHARGE indicator light extinguishing.

f. Disconnect the battery discharger cable from the cable of the battery that has been discharged.

g. Install the AC POWER INPUT cable in the cover of the PP-4127/U and secure the cover, unless it is required for a charging procedure.



## CHAPTER 3

### OPERATOR AND ORGANIZATIONAL MAINTENANCE

#### 3-1. Scope of Maintenance

The maintenance duties assigned to the operator and organizational repairman for the PP-4127/U are listed below, together with a reference to the paragraphs covering the specific maintenance functions. Tools and test equipment required for maintenance are listed in appendix C.

- a. Operator's daily preventive maintenance checks and services chart (para 3-4).
- b. Operator's weekly preventive maintenance checks and services chart (para 3-5).
- c. Organizational monthly preventive maintenance checks and services chart (para 3-6).
- d. Organizational quarterly preventive maintenance checks and services chart (para 3-7).
- e. Cleaning ( para 3-8).
- f. Touchup painting (para 3-9)
- g. Troubleshooting (para 3-10 and 3-11).
- h. Replacement of indicator lamps (para 3-12).

#### 3-2. Preventive Maintenance

Preventive maintenance is the systematic care, servicing, and inspection of the PP-4127/U to prevent occurrence of trouble, reduce downtime, and insure that the equipment is serviceable.

a. *Systematic Care.* Procedures given in paragraphs 3-4 through 3-8 cover routine systematic care and cleaning essential to the

proper upkeep and operation of the equipment.

b. *Preventive Maintenance Checks and Services.* The preventive maintenance checks and services charts (para 3-4 through 3-7) outline functions to be performed at specific intervals. These checks and services are to maintain Army electronic equipment in a combat-serviceable condition; that is, in good general (physical) condition and in good operating condition. To assist operators in maintaining combat serviceability, the chart indicates what to check, how to check, and the normal indications. The *References* column lists the paragraphs or manuals that contain detailed repair or replacement procedures. If the defect cannot be remedied by performing the corrective actions listed, a higher category of maintenance or repair is required. Records and reports of these checks and services must be made in accordance with requirements given in TM 38-750.

#### 3-3. Preventive Maintenance Checks and Services Periods

Preventive maintenance checks and services of the equipment are required daily, weekly, monthly, and quarterly. Paragraph 3-4 specifies the checks and services that must be accomplished daily (or at least once a week if the equipment is maintained in a standby condition). Paragraphs 3-5, 3-6, and 3-7 specify additional checks and services that must be performed weekly, monthly, and quarterly.

#### 3-4. Operator's Daily Preventive Maintenance Checks and Services Chart

Sequence No.	Item to be Inspected	Procedure	References
1	Completeness -----	Check to see that equipment is complete -----	App. B. Para 3-8.
2	Exterior surfaces -----	Clean exterior surfaces, including panel and meter glasses. Check all meter glasses and indicator lenses for cracks.	

Sequence No.	Item to be inspected	Procedure	References
3	Connectors -----	Check tightness of all connectors -----	None.
4	Controls and indicators _	While making operating checks (items 5, 6, and 7), check to see that the mechanical action of each switch is smooth and free of external or internal binding, and that there is no excessive looseness. Also, check meters for sticking or bent pointers.	
5	SELECTOR SWITCH _	Check to see that SELECTOR SWITCH of battery charger is down for 115-vac input power, or up for 230-volt ac input power.	
6	Battery charger operation	During operation be alert for any abnormal indication.	
7	Battery discharger operation.	During operation, be alert for any abnormal operation.	

**3-5. Operator's Weekly Preventive Maintenance Checks and Services Chart**

Sequence No.	Item to be inspected	Procedure	References
1	Cable -----	Inspect cables for chafed, cracked, or frayed insulation. Replace connector that is broken, arced, stripped, or excessively worn.	None.
2	Metal surfaces -----	Inspect exposed metal surfaces for rust and corrosion; clean and touchup paint as required.	Para 3-9.
3	Handles and latches ----	Inspect handles, latches, and hinges for looseness; replace or tighten, as necessary.	

**3-6. Organizational Monthly Preventive Maintenance Checks and Services Chart**

Sequence No.	Item to be inspected	Procedure	References
1	Transformer terminals --	Inspect terminals on power transformer. All nuts must be tight. There should be no evidence of dirt or corrosion.	None.
2	Terminal blocks -----	Inspect terminal blocks for loose connections and cracked or broken insulation.	None.
3	Resistors and capacitors	Inspect resistors and capacitors for cracks, blistering, or other defects.	None.
4	Gaskets and insulators _	Inspect gaskets, insulators, bushings, and sleeves for cracks, chipping, and excessive wear.	None.
5	Interior -----	Clean interior of chassis and cabinet.	Para 3-8.

**3-7. Organizational Quarterly Preventive Maintenance Checks and Services Chart**

Sequence No.	Item to be inspected	Procedure	References
1	Publications -----	See that all publications are complete, serviceable, and current	DA Pam 310-4.
2	Modifications -----	Check DA Pam 310-4 to determine whether new applicable MWO's have been published. All URGENT MWO's must be applied immediately. All NORMAL MWO's must be scheduled.	TM 38-750 and DA Pam 310-4.



**3-8. Cleaning**

Inspect the exterior of the equipment; exterior surfaces should be free of dust, dirt, grease, and fungus.

a. Remove dust and loose dirt with a clean, soft cloth.

**WARNING**

Adequate ventilation should be provided while using TRICHLOROTRIFLUOROETHANE. Prolonged breathing of vapor should be avoided. The solvent should not be used near heat or open flame the products of decomposition are toxic and irritating. Since TRICHLOROTRIFLUOROETHANE dissolves natural oils, prolonged contact with the skin should be avoided. When necessary, use gloves which the solvent cannot penetrate. If the solvent is taken internally, consult a physician immediately.

b. Remove grease, fungus, and ground-in dirt from the case; use a cloth dampened (not wet) with cleaning compound.

c. Remove dust or dirt from the BATTERY (A), BATTERY (B), and battery discharger cable connectors with a brush.

**CAUTION**

Do not press on the meter faces (glasses) when cleaning meters may become damaged.

d. Clean the control panels and meters with a soft, clean cloth. If necessary, dampen the cloth with

water; mild soap may be used for more effective cleaning.

**3-9. Touchup Painting Instructions**

a. *Rustproofing.* When the finish on the PP-4127/U has become badly scarred or damaged, rust and corrosion can be prevented by touching up the bare surfaces. Use No. 000 sandpaper to clean the surface down to the bare metal. Obtain a bright, smooth finish.

b. *Painting.* Remove rust and corrosion from metal surfaces by lightly sanding them with fine sandpaper. Brush two thin coats of paint on the bare metal to protect it from further corrosion. Refer to the applicable cleaning and refinishing practices specified in TB 43-0118.

**3-10. General Troubleshooting Information**

**CAUTION**

When troubleshooting the battery charger of the PP-4127/U, be sure that the AC POWER INPUT cable connector is connected to a polarized, three-pin socket so that the chassis will be grounded to the input power source.

Troubleshooting the PP-4127/U at the organizational category is based on an operational check. To troubleshoot the PP-4127/U, perform the operation functions until an abnormal indication or result is observed; then, perform checks and corrective actions indicated in the troubleshooting chart. If the corrective measures indicated do not result in the correction of the trouble, higher maintenance category repair is required.

**3-11. Organizational Troubleshooting Chart**

a. *Battery Charger.*

Item No.	Trouble symptom	Probable trouble	Checks and corrective measures
1	POWER ON indicator light does not illuminate when AC POWER switch is set to ON.	a. Defective AC POWER INPUT cable or cable connector.  b. Defective power interlock switch, AC POWER switch, or SELECTOR SWITCH. c. CIRCUIT BREAKERS tripped.	a. Check continuity of cable and connector; repair or replace as required. b. Higher maintenance category repair is required. c. Depress CIRCUIT BREAKERS.
2	Appropriate indicator light does not illuminate as required.	Defective indicator lamp . . . . .	Replace indicator lamp (para 3-12).
3	Test METER (A) or TEST METER (B) does not indicate charging current.	Meter is defective . . . . .	Higher maintenance category repair is required.

*b. Battery Discharger*

Item No.	Trouble symptom	Probable trouble	Checks and corrective measures
1	<b>DISCHARGE indicator light does not illuminate when DISCHARGE switch is actuated.</b>	<b>Defective battery discharger cable or connector.</b>	<b>Check continuity of cable and connector; repair or replace as required.</b>
2	<b>DISCHARGE indicator light illuminates when DISCHARGE switch is actuated, but goes off when switch is released.</b>	<b>Battery potential is less than 4.2 ±0.1 volts, or discharge cutoff level not properly set.</b>	<b>Higher maintenance category repair is required.</b>

**3-12. Replacement of Indicator Lamps**

**NOTE**

Be sure that the O-ring underneath the lens is not lost when removing the lens and lamp.

a. Turn the indicator lamp light lens counterclockwise to unscrew it. The indicator lamp will remain in the lens, and the O-ring should remain on the indicator light socket. If the O-ring comes off with the lens, retain it.

b. Grasp the flange of the indicator lamp with fingernails and pull the indicator lamp out from the lens.

c. Insert the new indicator lamp into the lens.

d. Install the O-ring over the threaded portion of the indicator light socket.

e. Install the lens and lamp; turn the lens clockwise until it is screwed onto the indicator light socket.

## CHAPTER 4

### FUNCTIONING OF EQUIPMENT

---

#### Section I. BATTERY CHARGING CIRCUITRY

##### 4-1. Basic Ac Phase-Controlled Current Regulator

a. Figure 4-1 is a simplified schematic diagram of a basic ac phase-controlled current regulator. The voltage for the charging current to the battery is supplied by the bridge circuit, made up of CR6006, CR6007, and silicon-controlled rectifiers SCR6001 and

current to the battery, and CR6005 is a commutating diode that provides a current path between L6001 and the battery when rectifiers SCR6001 and SCR6002 are not conducting. Resistor R6009 removes inductive transients from L6001 (fig. 9-4). The dc current through the battery is controlled by varying the conduction time of SCR6001 and SCR6002. Figure 4-2 shows the voltage at the cathodes of rectifiers SCR6001 and SCR6002 with respect to P6001-6. The dc component of the voltage is proportional to the conducting angle. The dc current in the charging path is determined by the difference between the sum of the dc component of the rectified voltage and the battery voltage, divided by the resistance in the charging path. As the battery voltage changes (or the ac line voltage changes), the conduction angle of the SCR is varied so that a constant current is maintained through the battery.

b. Bridge rectifiers CR6001 through CR6004, resistor R6001, Zener diode CR6116, and RF filter capacitors C6001 and C6002 (fig. 9-4) provide a clipped sine wave voltage that is in phase with the charging path ac voltage. This clipped sine wave is used as a power supply for a multivibrator circuit that consists of R6122 and C6114, and unijunction

transistor (UJT) Q6104. The UJT has three terminals: the emitter, base 1, and base 2. Between base 1 and base 2, UJT has the characteristics of an ordinary resistance. The emitter is reverse-biased until the emitter-base voltage is greater than the emitter peak voltage ( $V_p$ ). The emitter peak voltage ( $V_p$ ) independent on the base 1 to 2 voltage ( $V_b$ ), and is approximately equal to  $0.6 V_{bb}$ . When the emitter voltage ( $V_e$ ) exceeds the emitter peak voltage ( $V_p$ ), the UJT turns on and the resistance between the emitter and base 1 is very low, allowing emitter current to flow. Voltage divider R6123 and R6124 (fig. 9-4) provide the Q6104 base 1 to base 2 bias voltage.

c. Figure 4-3 shows a basic UJT multivibrator circuit. Capacitor C6114 is charged to the potential at resistor R6122 until the emitter voltage ( $V_e$ ) reaches the emitter peak voltage ( $V_p$ ). At this time, the UJT turns on and discharges C6114 through R LOAD. When the emitter voltage falls to about 2 volts, conduction ceases and the cycle is repeated.

d. In the ac phase-controlled circuit (fig. 4-1), the clipped sine wave voltage is used as the supply voltage for the UJT multivibrator. The voltage across R6003 is proportional to the current flowing through the battery and is compared to a reference voltage and amplified in differential comparator A6102. The output of A6102 is coupled to capacitor C6114 in the multivibrator circuit through the collector of Q6103 and CR6115, so that the beginning of the charging cycle in the UJT emitter circuit is controlled by a pedestal voltage derived from the current flow in the battery-charging path.

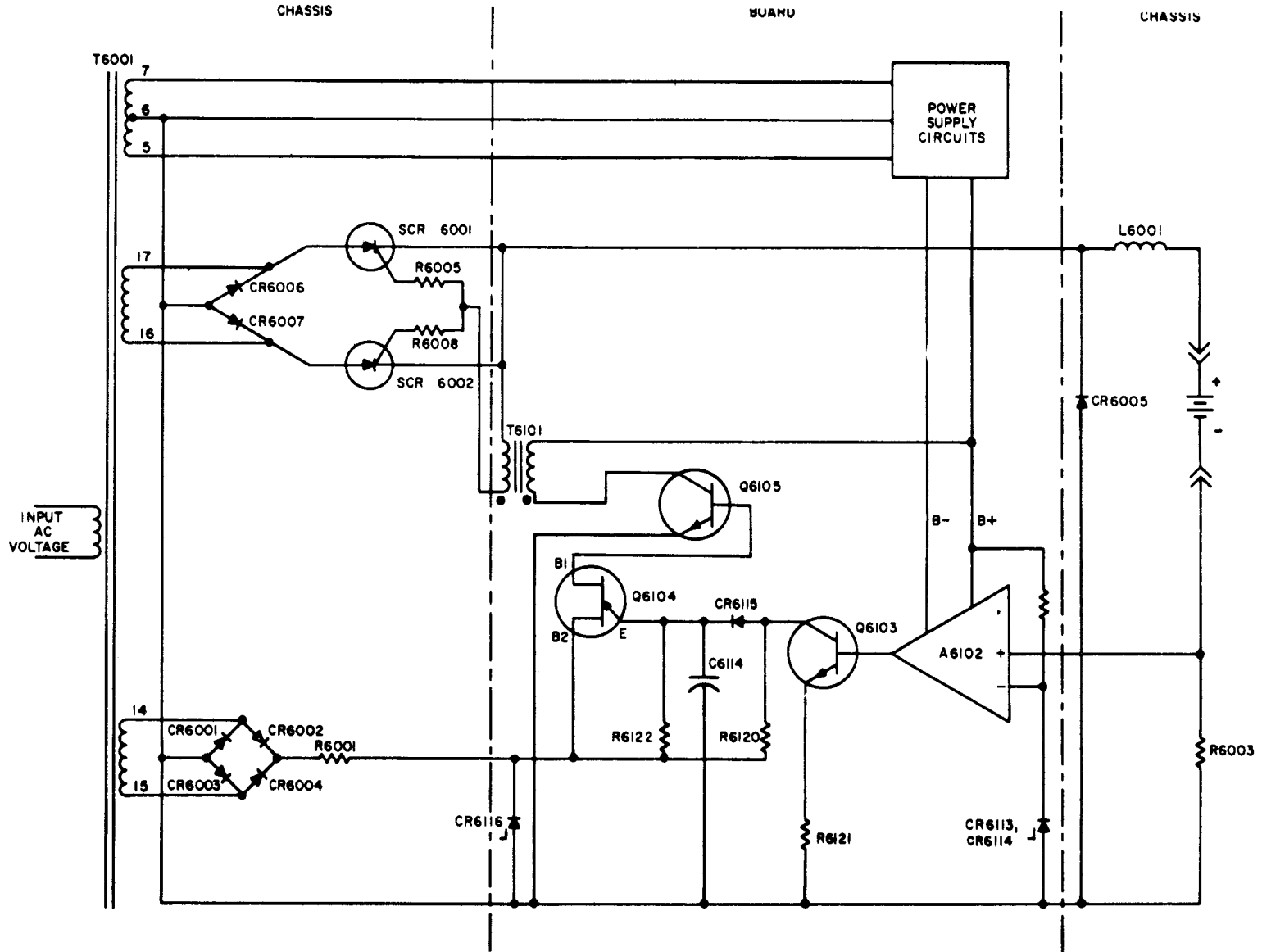

Figure 4-1. Basic ac phase-controlled current regulator, simplified schematic diagram.

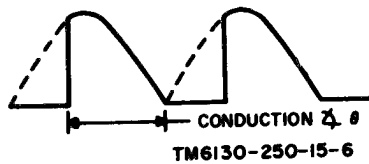

Figure 4-3. Voltage at cathode of SCR.

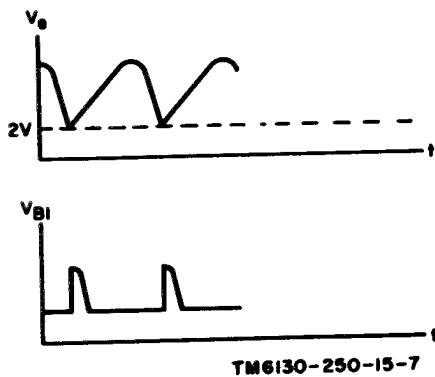
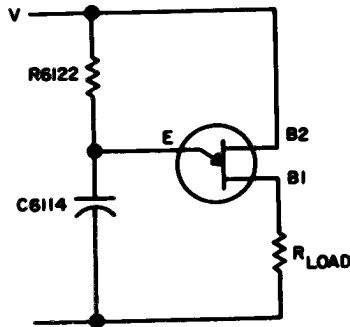

Figure 4-3. Basic UJT multivibrator circuit

e. Figure 4-4 shows waveforms in the trigger circuit. At the beginning of each cycle, the clipped sine wave rises to its maximum voltage, and C6114 is brought rapidly to the pedestal voltage by the collector circuit of Q6103 and CR6115 (fig. 4-1). Capacitor C6114 continues to charge toward the UJT base 1 to base 2 voltage ( $V_{bb}$ ), through R6122 and CR6115, until it reaches the emitter peak voltage ( $V_p$ ), and *whereupon* the UJT fires. The trigger is then coupled to the SCR gates through pulse transformer T6101, firing the SCR whose anode-to-cathode voltage is positive. Diode CR6129 (fig. 9-4)

clamps the base of the trigger pulse. The other SCR anode circuit is reversed by bias due to the bridge arrangement and, therefore, does not conduct.

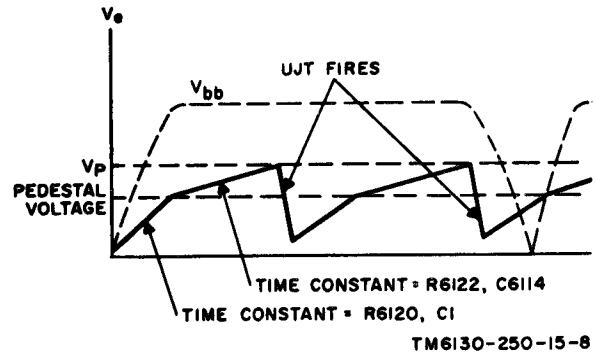

Figure 4-4. Trigger circuit waveforms.

f. The time at which the UJT fires is controlled by the pedestal voltage. As the pedestal voltage increases, the time required for the capacitor voltage to reach the emitter peak voltage ( $V_p$ ) is decreased; as the pedestal voltage decreases, the time is increased. Changes in current flow in the battery-charging path are felt at R6003 and produce an error signal at the input of differential comparator A6102 that causes a corresponding change in the pedestal voltage. This, in turn, changes the firing angle of SCR6001 and SCR6002, and reduces the error signal and maintains a constant current flow in the battery-charging path. Resistors R6005 and R6008 provide trigger isolation.

#### 4-2. Detailed Circuit Description

a. *Input Power Circuit* (fig. 9-4). The input power circuit consists of the ac power input cable and connector P6001, filters FL6001 and FL6002, power interlock switch S6005, AC POWER switch S6001, SELECTOR SWITCH S6002, CIRCUIT BREAKERS CB6001 and CB6002, POWER ON indicator light DS6001, and power transformer T6001. Power interlock switch S6005 is actuated when the chassis is installed in its case, and interrupts one leg of the input ac power when the

chassis is removed from its case. SELECTOR SWITCH S6002 has a switch guard that must be loosened to set the SELECTOR SWITCH S6002 to 115 V (switch guard pushed down), or 230 V (switch guard pushed up). For 115-volt ac input power operation, when SELECTOR SWITCH S6002 is set to 115 V, the two primary windings of transformer T6001 are connected in parallel. For 230-volt ac input power operation, when SELECTOR SWITCH S6002 is set to 230 V, the two primary windings of transformer T6001 are connected in series. POWER ON indicator light DS6001 is connected across one set of the primary windings of the transformer and illuminates to indicate the presence of input power when AC POWER switch S6001 is set to ON, and power interlock switch S6005 is actuated. CIRCUIT BREAKERS CB6001 and CB6002 provide circuit protection in the event of short circuits or overloads. Although the chassis is grounded to the input power source ground, the internal circuitry of the battery charger is referenced to the negative terminal of the battery being charged for a floating ground. The returns of all internal power sources are referenced to this floating ground.

*b. Charging Voltage Circuit* (fig. 9-4). Secondary winding terminals 16 and 17 of transformer T6001 provide the voltage for the charging circuits of both batteries. The bridge circuit, comprised of CR6006, CR6007, and SCR6001 and SCR6002, provides the charging voltage for battery A; CR6006, CR6007, and SCR6003 and SCR6004 provide the charging voltage for battery B. Control of the charging current is achieved by controlling the conduction time of SCR6001 and SCR6002 for battery A, and SCR6003 and SCR6004 for battery B. Inductor L6001 and filter FL6003 filter the charging current to battery A; inductor L6002 and filter FL6005 filter the charging current to battery B. TEST METER (A) M6001 is connected in the charging current path for battery A; TEST METER (B) M6002 is connected in the charging current path for battery B. Meters provide indications of the charging current flowing through their respective batteries. BATTERY (A) connector J6001, on the front panel of the battery charger, provides the means of connecting the

battery A cable connector to the battery to be charged. The charging voltage is applied to the positive terminal of battery A through pin 4 of J6001, and the negative terminal of the battery is connected to pin 2 of J6001. BATTERY (B) connector J6001 provides means of connecting BATTERY (B) cable connector to the battery to be charged. The charging voltage is applied to the positive terminal of battery B through pin 4 of J6002, and the negative terminal of the battery is connected to pin 2 of J6002.

*c. Charging Current Control Circuit.*

- (1) Secondary terminals 14 and 15 of transformer T6001 and CR6001, through CR6004, provide the full-wave rectified sine wave for both charging current control circuits. This sine wave is in phase with the charging voltage circuit ac voltage. For the battery A control circuit, the sine wave is applied as the power supply voltage to the UJT multivibrator Q6104 circuit through the contacts (pins 4 and 5) of battery A voltage cutoff relay K6101. The battery A sine wave is clipped by the combination of R6001, CR6116, C6001, and C6002.
- (2) Transformer T6001 secondary terminals 5 and 7 provide an output that is fed to the printed circuit board, where it is rectified, filtered, and regulated by CR6108 through CR6111, filter capacitors C6107 through C6110 and resistors R6125 and R6126. This power supply provides +10 volts at the cathode of Zenor diode CR6112, and -10 volts at the anode of Zenor diode CR6113. Zenor diode CR6114 is used to drive a reference voltage supply that is divided to about 0.3 volt by resistor R6128 and R6129.
- (3) A portion of the voltage at R6003 (which is connected between the negative terminal of battery A and the internal power supplies' return) is picked off by the voltage divider consisting of R6112, R6113, and R6114. The voltage picked off by

the wiper arm of potentiometer R6113 is compared resistively by resistors R6115 and R6116 with the voltage at the junction of resistors R6128 and R6129 (the reference 0.3 volt at operational amplifier A6102 ). This comparison voltage is indicative of the current flowing through battery A. Capacitor C6111 bypasses the ripple in the charging voltage. The gain of operational amplifier A6102 is determined by feedback network R6117, 6118, and CR6127. Capacitors C6112 and C6113, and resistor R6119 are used to frequency compensate amplifier A6102. Capacitor C6123 filters the negative supply voltage from CR6113 applied to A6102. The output of A6102 is applied to the base of transistor Q6103 for further amplification. Resistor R6120 is the collector load resistor for Q6103; resistor R6121 limits the emitter current. The amplified output is then applied to the UJT trigger circuit from the collector of Q6103 through CR6115. When UJT Q6104 fires, the base 1 output is amplified in Q6105 and coupled to SCR6001 and SCR6002 gates of the battery charging voltage circuit by pulse transformer T6101. Battery B charging current control circuit operates in the same way as the battery A control circuit; it uses the circuit made up of A6103, Q6106, Q6107, Q6108, and pulse transformer T6102 to control SCR6003 and SCR6004 gates in the battery B charging voltage circuit.

*d. Charging Voltage-Sensing and Cutoff circuit.* Transformer T6001 secondary winding terminals 8 and 10 provide an output to the printed circuit board, where it is rectified, filtered, and regulated by a power supply which consists of CR6101 through CR6104 and associated circuitry. (This secondary winding also provides an ac voltage for the operation of the CHARGE ON and OFF indicator lights.) The power supply filter,

which consists of capacitors C6101, and C6102 and resistor R6101, provides +10 volts at the cathode of CR6105. The power supply filter, which consists of capacitors C6103 and C6104 and resistor R6107, provides -6 volts at the anode of CR6106 for operation of the battery. A charging voltage-sensing and cutoff circuitry. Zenor diode's CR6105 and CR6107 and resistor R6102 provide a 6-volt reference voltage that is divided down to about 3 volts by resistors R6103 and R6104. This is applied to terminal 3 of amplifier A6101 through the filter, which consists of resistor R6105 and capacitor C6105. The positive terminal of battery A is connected to potentiometer R6109 through pin 5 of J6001. Resistors R6108, R6109, and R6110 form a voltage divider network that supplies a portion of the battery voltage to the wiper arm of potentiometer R6109. This voltage is filtered by resistor R6111 and capacitor C6131 and applied to terminal 4 of amplifier A6101. Potentiometer R6109 is set so that the sensing circuitry will detent when the battery is charged to  $8.1 \pm 0.16$  volts. When the voltage picked off by R6109 exceeds the reference voltage at R6104 (indicating that the battery voltage has reached its fully charged state), the output of differential comparator A6101 (pin 7) becomes positive, and causes transistor Q6101 to conduct, Capacitor C6133 and resistor R6106 filter the voltage applied to transistor Q6101 to prevent transient voltage from triggering Q6101. Capacitor C6106 filters transient voltages from Q6101 when relay K6101 contacts are switched. The latching coil of relay K6101 is connected in the collector circuit of Q6101 so that, when current flows in Q6101, the latching coil is energized. When relay K6101 is energized, the sine wave power supply to UJT multivibrator Q6104 is interrupted (terminals 3 and 5 of K6101 ). This prevents the multivibrator circuit from producing an output to turn on gates SCR6001 and SCR6002 in the battery charging voltage circuit. This action removes the charging voltage from battery A; when the gates are shut off, no rectification for battery charging takes place. A second set of contacts of relay K6101 controls the operation of the battery A CHARGE ON and OFF indicator lights. When relay K6101

is energized, the ac voltage at terminal 6 of relay K6101 is disconnected from the CHARGE ON indicator light and applied to the CHARGE OFF indicator light. RESET (A) switch S6003 controls the resetting of relay K6101 once it is energized by the sensing of a fully charged battery. When the RESET (A) switch is momentarily held in its down position, the reset coil of relay K6101 is energized, and relay K6101 is reset so that the clipped sine wave power supply is again connected to the UJT multivibrator circuit. This condition brings the battery charging current control circuit back into operation. At the same time, the CHARGE OFF indicator light extinguishes, and the CHARGE ON indicator light illuminates. Operation of the charging voltage-sensing and cutoff circuit for battery B is the same as for battery A. The battery B circuit has its own power supply circuit, which consists of CR6120 through CR6123 and associated circuitry. The battery B voltage is applied to potentiometer R6154, differential comparator A6104 controls the operation of Q6109 and relay K6103, and relay K6103 controls the application of the battery B clipped sine wave power supply to UJT multivibrator Q6107 of the battery B charging current control circuit.

e. *Input Frequency Compensating Circuit.*  
A frequency detecting circuit, which controls

the operation of relay K6102, automatically adjusts the time constants in the UJT emitter circuits of both charging current control circuits for 60-cps input power frequency. The time constants of the UJT circuits are preset for 400-cps operation. The resistor-capacitor (rc) network, R6130 and C6117 and transistor Q6102, forms the frequency detecting circuit. When the input line frequency is 400 cps, the output of the rc network is not great enough to exceed the threshold voltage of the base-emitter circuit of Q6102, in series with diode CR6117, and transistor Q6102 does not conduct. The coil of relay K6102 is connected in the collector circuit of Q6102. When the input line frequency is 60 cps, the output of the rc network exceeds the threshold voltage and Q6102 conducts. The detected current is amplified in the collector circuit of Q6102 and energizes relay K6102. Capacitor C6132 filters and smooths the current through the relay coil. When relay K6102 is energized, relay K6102 contacts place capacitor C6115 in parallel with C6114 (battery A control circuit), and capacitor C6122 in parallel with C6121 (battery B control circuit). This added capacitance adjusts the time constants in the UJT multivibrator emitter circuits for 60-cps operation.

## Section II. BATTERY DISCHARGER CIRCUITRY

### 4-3. Turn-on Circuitry

(fig. 4-5)

When battery discharger cable connector P6201 is connected to the cable connector of the battery to be discharged and DISCHARGE switch S6201 is actuated, the coil of relay K6201 is connected across the battery potential and is energized through the circuit made through the switch contacts. When the relay K6201 is energized, contacts of relay K6201 connect the battery voltage across discharge load resistor R6208 and the voltage-sensing and cutoff circuitry. This condition is indicated by the DISCHARGE indicator light illuminating.

### 4-4. Discharger Voltage-Sensing and Cutoff Circuitry

(fig. 4-5)

When the battery potential is connected to the voltage-sensing and cutoff circuitry, current amplifier Q6201 conducts, and provides the driving current necessary for transistor Q6202. The threshold level of transistor Q6202 is set by potentiometer R6205; the wiper arm of R6205 is connected to the base of transistor Q6202. Potentiometer R6205 is connected in a voltage divider network that is connected across the battery potential when relay K6201 is energized. If the battery voltage is greater than  $4.2 \pm 0.1$  volts, transistor



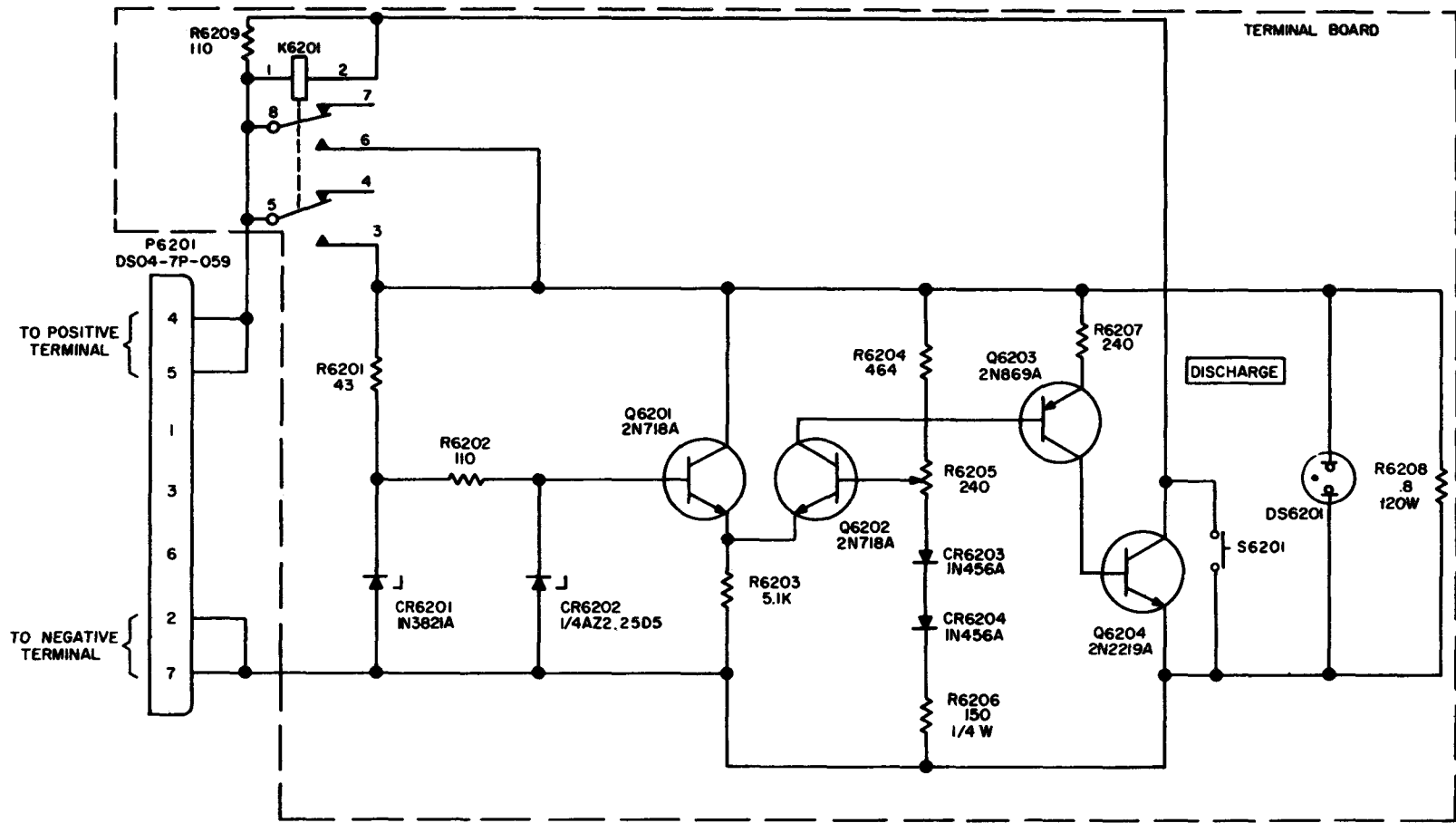

NOTES:

1. UNLESS OTHERWISE SPECIFIED:  
RESISTOR VALUES ARE IN OHMS
2.  = PANEL MARKING

TM6130-250-15-9

Figure 4-5. Battery discharger, schematic diagram.

Q6202 will conduct and turn on transistor Q6203. When transistor Q6203 conducts, it turns on transistor Q6204. The emitter-collector circuit of transistor Q6204 is connected in parallel with the DISCHARGE switch contacts; when transistor Q6204 is conducting, it completes the circuit from the relay coil to the negative terminal of the battery, and holds the relay coil energized when the DISCHARGE switch is released. (The relay coil circuit is initially completed by the DISCHARGE switch contacts.) Resistor R6209 reduces the Q of the relay coil. The voltage-sensing and cutoff circuitry will remain in this state until the battery current through discharge load resistor R6208 causes the voltage level of the battery to drop to  $4.2 \pm 0.1$  volts. When the battery voltage drops to  $4.2 \pm 0.1$  volts, the voltage picked off by the wiper arm of potentiometer R6205, and connected to the base of transistor Q6202, is not sufficient to keep transistor Q6202 conducting; transistor Q6202 is shut off and, in turn, shuts off transistor Q6203. When transistor Q6203 is shut off, transistor Q6204 stops conducting and the coil circuit of relay K6201 is effectively opened; then relay K6201 deenergized and disconnects the battery voltage from the dis-

charge load resistor and the voltage-sensing and cutoff circuitry. The DISCHARGE indicator light will extinguish. Actuating the DISCHARGE switch at this time (or with a battery that is discharged to  $4.2 \pm 0.1$  volts) will energize relay K6201, which will connect the battery voltage to the voltage-sensing and cutoff circuitry and the discharge load resistor; however, as soon as the DISCHARGE switch is released, relay K6201 will be deenergized because the voltage-sensing and cutoff circuitry will immediately go into its cutoff state. The sensing circuitry will not operate to hold relay K6201 energized because the threshold level of transistor Q6202 was not reached and could not turn the relay holding circuit on to keep the relay energized. Zener diodes CR6201 and CR6202, with resistors R6201 and R6202, provide a regulated reference voltage at the base of transistor Q6201. The voltage divider, which consists of resistors R6202, R6205, and R6206 and diodes CR6203 and CR6204, senses the drop in the battery potential. Diodes CR6203 and CR6204 provide temperature compensation, and resistor R6207 provides the base to emitter bias for transistor Q6203.

## CHAPTER 5

### TROUBLESHOOTING

---

#### Section I. GENERAL TROUBLESHOOTING TECHNIQUES

**Warning:** When servicing the battery charger of the PP-4127/U, be extremely careful of the high voltages and currents that exist in it. Serious injury or death may result from contact with the output terminals. Deenergize the equipment, and disconnect it from the input power source before performing any maintenance.

#### 5-1. General Instructions

Troubleshooting at the direct support, general support, and depot maintenance categories includes all techniques given for organizational maintenance, and any special or additional techniques required to isolate a defective part. If one channel is malfunctioning, check the comparable circuits in the other channel, if possible.

#### 5-2. Organization of Troubleshooting Procedures

*a. General.* Troubleshooting procedures for the battery charger circuitry of the PP-4127/U are contained in paragraphs 5-4 through 5-9; and those for the battery discharger are contained in paragraphs 5-10 through 5-13. The first step in servicing a defective battery charger is to sectionalize the fault. Sectionalization means tracing the fault to a major circuit group of the battery charger, such as the input power circuit, the battery A or battery B charging voltage circuit, the battery A or battery B charging current control circuit, or the battery A or battery B charging voltage-sensing and cutoff circuit. In the battery discharger, sectionalization means determining whether the fault is in the turn-on circuit or the voltage-sensing and cutoff circuit. The second step is to localize the fault. Localization means tracing the fault to a defective stage of the circuit group responsible for the abnormal condition. The third step is isolation. Isolation means locating

the defective component or part in the circuit stage. Some defective parts, such as burned resistors and arcing or shorted transformers, can often be located by sight, smell, and hearing; however, most defective parts must be isolated by checking voltages and resistances.

*b. Sectionalization.* The battery charger circuitry is divided into two identical circuits, one for battery A and one for battery B. Some circuits, such as the input power circuit and the frequency compensating circuit, are common to both charging circuits. The battery discharger circuitry consists of two circuits: the turn-on circuit and the voltage-sensing and cutoff circuit. The first step in tracing trouble is to determine the circuit group at fault as follows:

- (1) *Visual inspection.* The purpose of visual inspection is to locate faults without testing or measuring circuits. All meter readings, or other visual indications, should be observed and an attempt made to sectionalize the fault to a particular circuit group.
- (2) *Operational tests.* An operational test frequently indicates the general location of trouble. In many instances, the test will help to determine the exact nature of the fault. The operating procedures (para 2-8), with the normally expected indications called out in the procedures, provide good operational tests.

c. *Localization.* Localization procedures should be performed after the trouble has been sectionalized. The troubleshooting charts (paras 5-5 and 5-11) should be used in localizing the trouble to a suspected stage. The troubleshooting charts list symptoms of common troubles and give (or reference) corrective measures. Such a chart cannot include all the trouble symptoms that may occur; the repairman should use the chart as a guide in analyzing symptoms that may not be listed.

**CAUTION**

Before using any ohmmeter to test transistors or transistor circuits, check in open circuit voltage across the ohmmeter test leads. Do not use the ohmmeter if the open circuit voltage exceeds 1.5 volt. Also, since the RX1 range normally connects the ohmmeter internal battery directly across the test leads, the comparatively high current (50 milliamperes (ma) or more) may damage the transistor under test. As a general rule, the RX1 range of any ohmmeter should not be used when testing low-powered transistors.

d. *Isolation.* After the fault has been localized to a stage by using the troubleshooting chart, voltage and resistance measurements and waveform checks should be made to isolate the defective component. A deviation of any appreciable amount from the voltage and resistance readings (paras 5-6, 5-7, 5-8, 5-12, and 5-13) will indicate a faulty part. The voltage checks will isolate the trouble to a group of parts, such as resistors, capacitors, and diodes; a resistance check will determine which part or component is defective. Waveform data and analysis (para 5-9) are also given for the battery

charger.

e. *Resistor and Capacitor Color Code Diagrams.* Color code diagrams for resistors and capacitors (figs. 9-1 and 9-2) provide pertinent resistance, voltage rating, and tolerance information.

f. *Component Locations.* Figures 5-1 through 5-5 and 9-3 show the component locations of the PP-4127/U.

**NOTE**

When making resistance checks, be careful of the test lead polarity. If the resistance reading is low, always reverse the test leads because of the diode action through a transistor. If a normal resistance is read after the leads are reversed, the stage is operating correctly.

g. *Unijunction Transistors.* If unijunction transistor Q6104 or Q6107 is suspected of being faulty, substitute a known good replacement rather than use the elaborate test setups required to check them.

h. *Test Cable.* Fabricate a test cable as shown in figure 5-6. Use a female connector (Deutsch model DS07-7S-308) that mates to BATTERY (A) and BATTERY (B) connectors, and four 6-inch lengths of AWG No. 14 insulated wire terminating in alligator clips.

**5-3. Test Equipment and Materials Required**

The chart below lists the test equipment and materials required for troubleshooting Charger, Battery PP-4127/U, and associated technical manuals. Some test equipment has been replaced and its replacement appears in the chart below. Use the replacement test equipment anytime the former test equipment is called for in this technical manual.

Test equipment	Replaced by	Technical Manual
Analyzer ZM-3/U	Bridge, Impedance ZM-71/U	TM 11-6625-2639-14
Multimeter TS-352/U	Multimeter, AN/USM-223/U	TM 11-6625-654-14
Oscilloscope AN/USM-140A	Oscilloscope, AN/USM-281C	TM 11-6625-2658-14
Test Set, Transistor TS-1836/U		TM 11-6625-539-15
Voltmeter, Electronic AN/USM-98.	Multimeter, Digital AN/USM-451	TM 11-6625-2953-14
Battery Charger PP-1659/G		
Resistor, variable 0-to 7.5 ohm, 1,000-watt (FSN 5905-195-4496).		TM 11-6130-238-12
Test cable (as fabricated).		

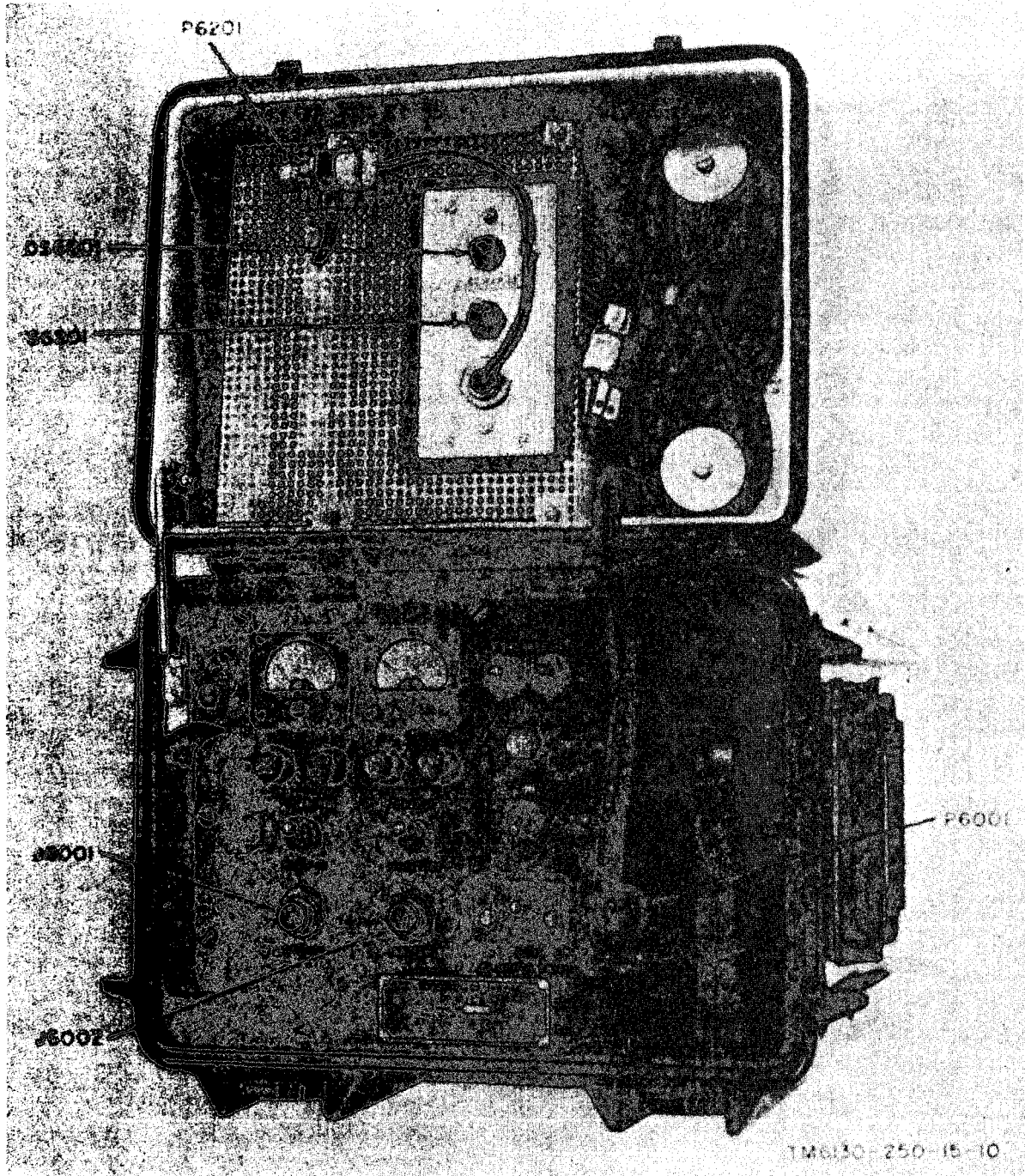

Figure 5-1. PP-4127/U component locations, front panels.

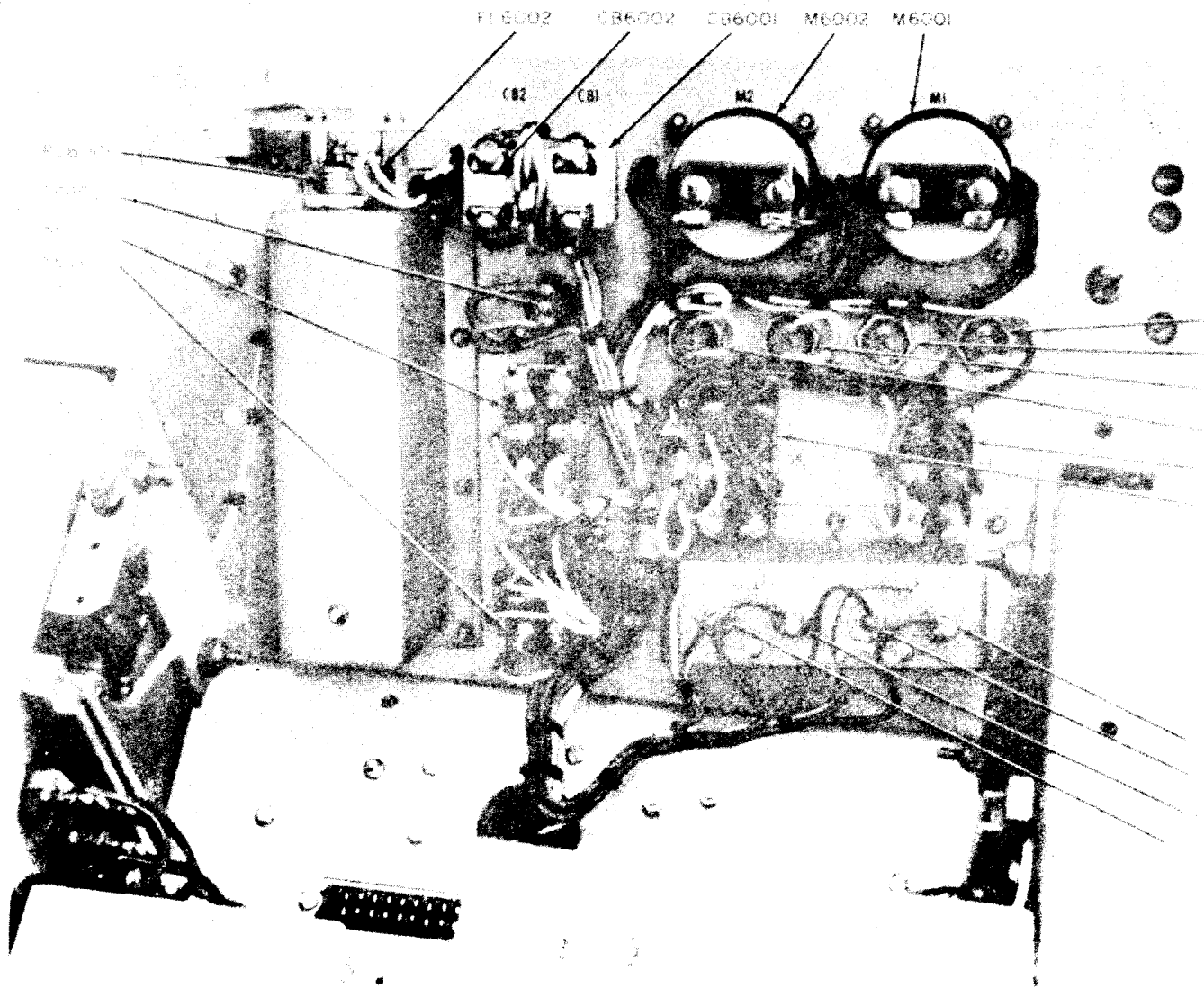

Figure 5-2. Battery charger component locations, rear of front panel.



Figure 5-3. Battery charger component locations interior view.

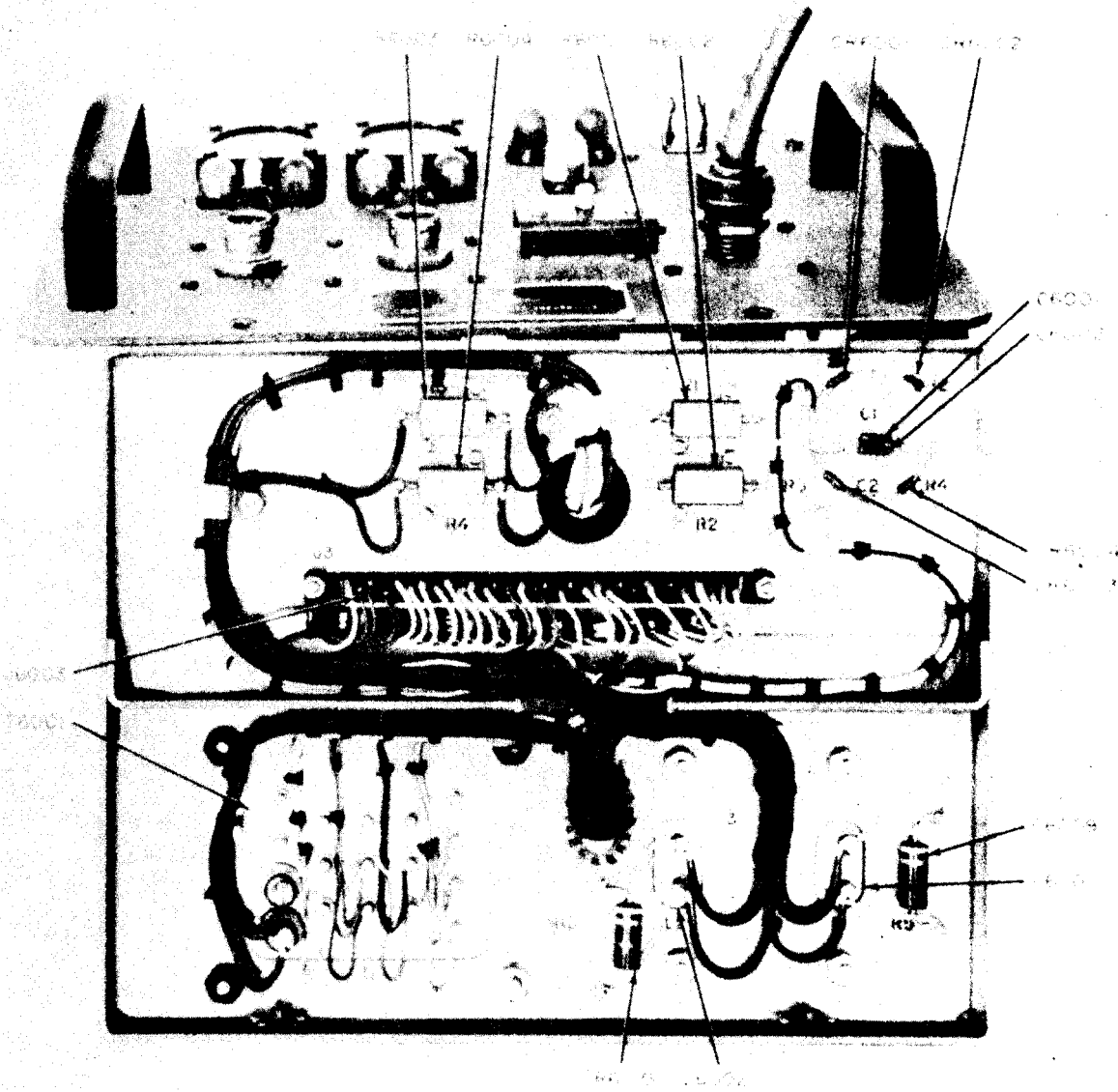
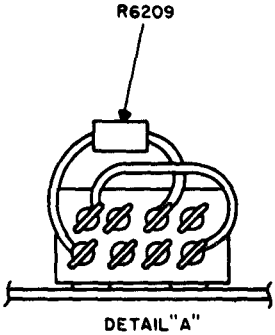
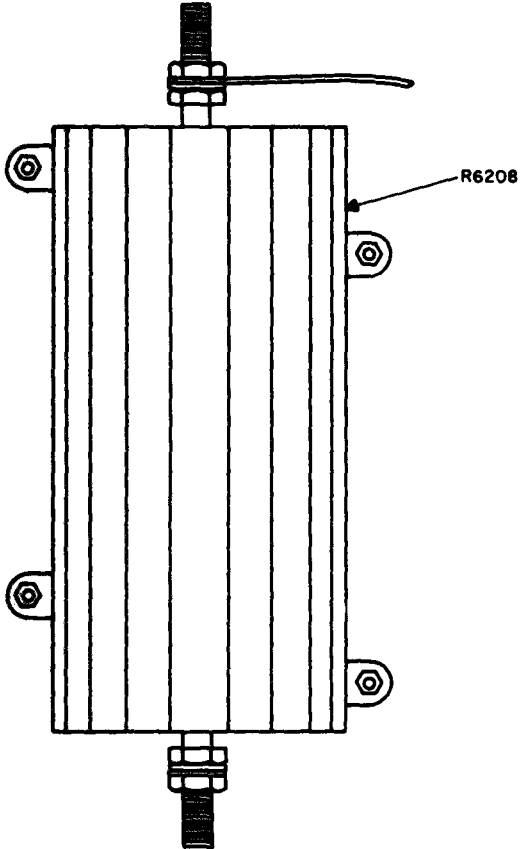
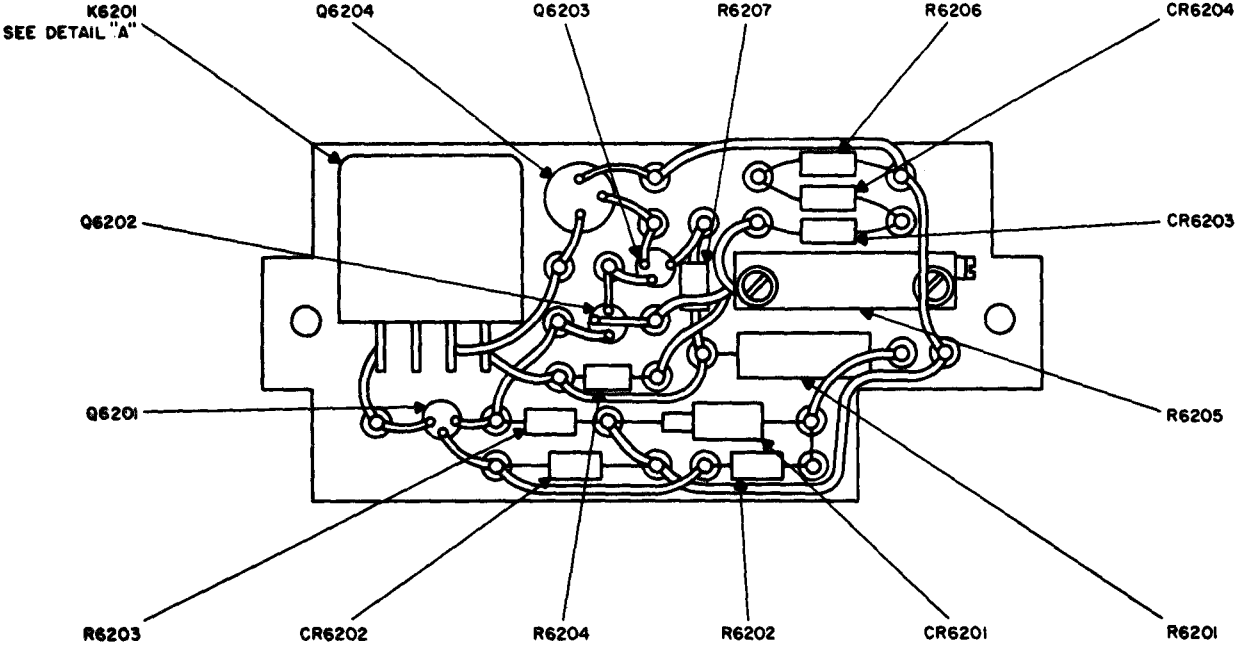

Figure 5-4. Battery charger component locations, bottom of chassis.





TM6130-250-15-15

Figure 5-5. Battery discharger component locations.

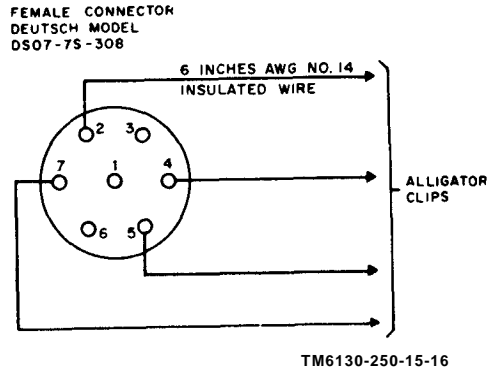

Figure 5-6. Test cable construction diagram.

**Section II. TROUBLESHOOTING BATTERY CHARGER CIRCUITRY**

**5-4. Troubleshooting Test Setup**

Before troubleshooting the battery charger, remove the battery charger chassis from its case ( para 6-2) so that all components are accessible, connect the battery charger to the input power source. Actuate the input power

interlock switch and connect two serviceable batteries (which have been partially discharged) to the BATTERY (A) and BATTERY (B) connectors.

**5-5. Battery Charger Troubleshooting Chart**

Item No.	Trouble symptom	Probable trouble	Checks and corrective measures
1	POWER ON indicator light does not illuminate when AC POWER switch is set to ON.	<ul style="list-style-type: none"> <li>a. AC power is not applied to battery charger.</li> <li>b. Defective power interlock switch, AC POWER switch, or SELECTOR SWITCH.</li> <li>c. CIRCUIT BREAKERS tripped.</li> </ul>	<ul style="list-style-type: none"> <li>a. Check for input voltage.</li> <li>b. Check switches; replace if defective.</li> <li>c. Check CIRCUIT BREAKERS; reset if tripped.</li> </ul>
2	CHARGE ON indicator light illuminates and no output current.	<ul style="list-style-type: none"> <li>a. Defective diodes CR6001 through CR6004.</li> <li>b. Defective power supply diodes CR6108 through CR6111.</li> <li>c. Defective UJT Q6104 (battery A) or Q6107 (battery B).</li> <li>d. Defective amplifier Q6105 (battery A) or Q6108 (battery B).</li> </ul>	<ul style="list-style-type: none"> <li>a. Check waveform at junction of R6001 and R6002 (fig. 5-7(1)). If waveform is not obtained, check diodes; replace if defective.</li> <li>b. Check diodes; replace if defective.</li> <li>c. Check waveforms (fig. 5-7(1)) at cathode of CR6115 or CR6118; across CR6116 or CR6119 (fig. 5-7(1)); at gate terminals of SCR6001 and SCR6002 or SCR6003 and SCR6004 (fig. 5-7(2)). If waveforms are not obtained, check UJT's (Q6104 and Q6107); replace if defective.</li> <li>d. Check transistor; replace if defective.</li> </ul>

Item No.	Trouble symptom	Probable trouble	Checks and corrective measures
		e. Defective diode CR6006 or CR6007, and SCR6001 and SCR6002 (battery A) or SCR6003 and SCR6004 (battery B).	e. Check waveform (fig. 5-7(1) and (2)) at L6001-1 or L6002-3, and at gate terminals of SCR6001 and SCR6002 (battery A) or SCR6003 and SCR6004 (battery B). If waveform is not obtained, check diodes or SCR; replace if defective.
3	CHARGE ON or OFF indicator lights do not illuminate or extinguish as required.	a. Defective lamp ----- b. Defective transistors Q6101 (battery A) or Q6109 (battery B). c. Defective relay K6101 (battery A) or K6103 (battery B). d. Defective RESET (A) or RESET (B) switch.	a. Check lamp; replace if defective. b. Check transistor; replace if defective. c. Check relay; replace if defective. d. Check switch; replace if defective.
4	Output current not regulated to $6 \pm 0.48$ amperes.	a. Potentiometer R6113 (battery A) or R6132 (battery B) not adjusted properly. b. Defective component in control circuitry : CR6108 through CR6114; A6102, Q6103, Q6104 (battery A) or A6103, Q6106, Q6107 (battery B), Q6102; or K6102.	a. Adjust potentiometer (para 6-7). b. Check waveforms (fig. 5-7(1) and (2)) at junction of CR6115 and R6122 or CR6118, R6143, C6121 ; across CR6116 or CR6109; at gate terminals of SCR6001 and SCR6002 or SCR6003 and SCR6004. If waveforms are not obtained, check components; replace if defective.
5	Charging current cuts off when charging voltage is less than 7.9 volts, or greater than 8.1 volts.	a. Potentiometer R6109 (battery A) or R6154 (battery B) not adjusted properly. b. Defective component in control circuitry: CR6101 through CR6107, A6101, Q6101, K6101, (battery A); or CR6120 through CR6126, A6104, Q6109, K6103 (battery B).	a. Adjust potentiometer (para 6-8). b. Check component; replace if defective.

**5-6. Dc Resistance Readings of Battery Charger Chassis**

The resistance readings given in the chart below are made at J6003 (with power disconnected and the printed circuit board removed) on the battery charger chassis. The resistance across P6001 (black to white) with the interlock switch (S6005) depressed is 1.2 ohm (S6002 at 115 V) and 4 ohms (S6002 at 230 V).

Test prods		Resistance (ohms)
Negative	Positive	
D	C	1.5
D	B	1.5
D	H	100
D	F	100
D	J	Infinity
D	A	Infinity
R	T	1.5
R	V	1.5
R	K	Infinity

Test prods		Resistance (ohms)
Negative	Positive	
R		Infinity
R	N	Infinity
R	S	Infinity
R	L	Infinity
R	E	Less than 1
R	X	Less than 1
R	M	Infinity
HH	KK	1.5
HH	JJ	1.5
HH	FF	100
HH	CC	100
HH	Y	Infinity
HH	LL	Infinity

**5-7. Dc Resistance Readings of Printed Circuit Board**

The resistance readings given in the chart below are made at P6101 with the printed circuit board removed from the chassis. The resistance measurements are provided as an aid in troubleshooting and are approximate values.

Test prods		Resistance (ohms)
Negative	Positive	
D	A	7.5K
D	B	12K
D	C	12K
D	F	Infinity
D	H	12K
D	J	3.5K

Test prods		Resistance (ohms)
Negative	Positive	
R	E	200
R	K	Infinity
R	L	Infinity
R	M	Infinity
R	N	Infinity
R	P	Not used
R	S	Infinity
R	T	10K
R	U	Not used
R	V	750K
R	W	Not used
R	X	200
HH	Y	3.5K
HH	Z	Infinity
	AA	Not used
	BB	Not used
HH	CC	Infinity
	DD	Not used
	EE	Not used
HH	FF	12K
HH	JJ	12K
HH	KK	12K
HH	LL	7.5K

**5-8. Battery Charger Voltage Test Points**

Perform the voltage checks shown in the chart below on the printed circuit board with Voltmeter, Electronic AN/USM-98. Note that some voltages are taken while the battery charger is generating charging current. The voltage checks are provided as an aid in troubleshooting and are approximate values.

Negative	Test prods		Indication (volts dc)	Test condition
	Positive			
P6101-D	-----	Junction of P6101-A and R6108. _	+610	No charging current.
P6101-D	-----	Junction of R6108 and R6109 ----	+2.3	No charging current.
P6101-D	-----	Junction of C6105, R6104, and R6105.	+2.1	No charging current.
P6101-D	-----	A6101-4 -----	-4.4	No charging current.
P6101-D	-----	A6101-2 -----	+2.1	No charging current.
P6101-D	-----	A6101-7 -----	-0.42	No charging current.
P6101-R	-----	Junction of R6113 and R6115 ----	a. +0.2 b. +0.3	a. No. charging current. b. Charging current for battery A.
P6101-R	-----	A6102-3 -----	a. 0 b. -0.2	a. Charging current for battery A. b. No charging current.
P6101-R	-----	A6102-7 -----	+8.6	No charging current.
P6101-R	-----	A6102-4 -----	a. -8 b. 0	a. No charging current. b. Charging current for battery A.
P6101-R	-----	A6102-2 -----	a. -0.2 b. +1.0	a. No charging current. b. Charging current for battery A.
P6101-R	-----	A6102-6 -----	-0.52	No charging current.
P6101-R	-----	Collector of Q6102 -----	-3.0	No charging current.

## 5-9. Waveform Analysis

a. Waveforms may be observed at various points in the circuitry of the battery charger with Oscilloscope AN/USM-140A. The normal waveforms obtained are shown in figures 5-7(1) and 5-7(2). By the comparison of the observed waveform with the normal waveform, trouble can sometimes be quickly located.

b. Before comparing the waveforms with the normal waveforms, carefully duplicate the conditions under which the normal waveforms

were obtained. If an observed waveform does not closely resemble the normal waveform, trouble is indicated.

c. A departure from the normal waveform indicates trouble between the point at which the waveform is observed to be normal and the point at which the waveform is observed to be abnormal; or, it may indicate a defective component in the circuitry immediately preceding the point at which the waveform was checked. A voltage or resistance check of the stage preceding the test point may isolate the defective component.

VOLTAGE POINT	REFERENCE POINT	OPERATING CONDITION	WAVEFORM
JUNCTION OF R6001 AND R6002	T6001-6	POWER ON BATTERY CHARGING	<p>A</p>
ACROSS CR6116 OR CR6119		POWER ON BATTERY CHARGING	<p>B</p>
L6001-1 OR L6002-3	T6001-6	POWER ON BATTERY CHARGING	<p>C</p>
JUNCTION OF C6115, R6122, CR6115 OR CR6118, R6143, C6121	P6101-R	POWER ON BATTERY CHARGING	<p>D</p>

TM6130-250-15-17①

Figure 5-7(1). Waveforms (part 1 of 2).

VOLTAGE POINT	REFERENCE POINT	OPERATING CONDITION	WAVEFORM
GATE OF SCR6001, SCR6002, SCR6003, OR SCR6004	T6001-6	POWER ON BATTERY CHARGING	<p>F</p> 
JUNCTION OF C6117, R6130, BASE Q6102	P6101-R	POWER ON BATTERY CHARGING	<p>G</p> 
COLLECTOR Q6105	P6101-R	POWER ON BATTERY CHARGING	<p>H</p> 
JUNCTION C6132 AND COLLECTOR OF Q6102	P6101-R	POWER ON BATTERY CHARGING	<p>I</p> 

Figure 5-7(2). Waveforms (part 2 of 2).

Section III. TROUBLESHOOTING BATTERY DISCHARGER CIRCUITRY

5-10. Preparation

Refer to paragraphs 6-5 and 6-6 for instructions on gaining access to components in

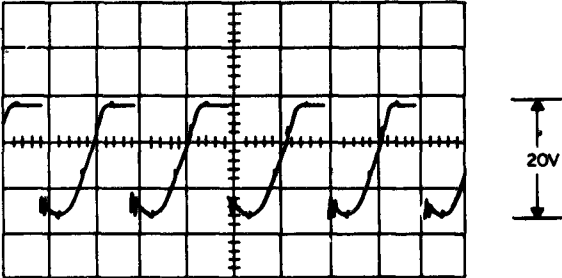
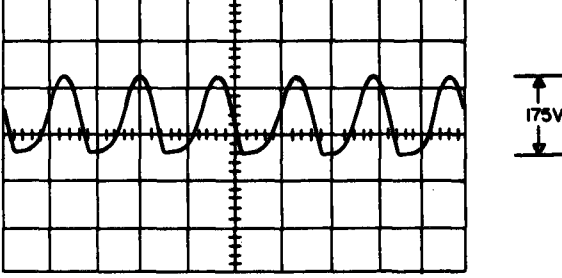
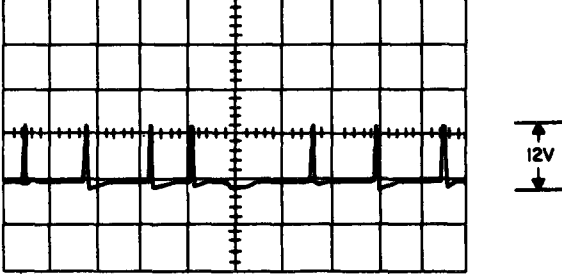
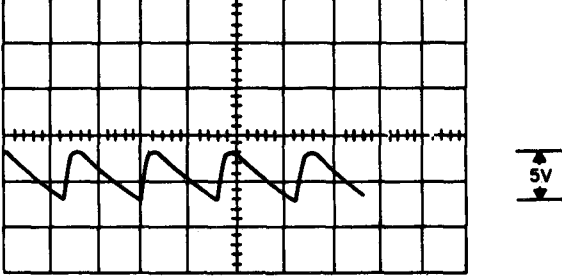
order to troubleshoot the battery discharger. Paragraphs 5-11, 5-12, and 5-13 provide troubleshooting techniques for locating a fault.

5-11. Battery Discharger Troubleshooting Chart

Item No.	Trouble symptom	Probable trouble	Checks and corrective measures
1	Indicator light DS6201 does not illuminate when DISCHARGE switch S6201 is actuated.	a. Defective lamp ----- b. Defective relay K6201 ----- c. Defective transmitter SCR6201, SCR6202, SCR6203, or SCR6204.	a. Check and replace as necessary. b. Check and replace as necessary. c. Check and replace as necessary.
2	Battery not discharging.	Defective resistor R6208 -----	Replace resistor.
3	Discharges to improper level.	Resistor R6205 improperly adjusted.	Adjust to 4.2 ± 0.1 volts ( para 6-10).

5-12. Dc Resistance Readings of Battery Discharger Circuit

Perform all resistance measurements given in the chart below with the negative side of R6208 used as a reference point.

Test prods		Resistance (ohms)
Negative	Positive	
Q6204 emitter -----	Q6201 emitter -----	12
Q6204 emitter -----	Q6201 base -----	4.5
Q6204 emitter -----	Q6201 collector -----	Less than 1 ohm
Q6204 emitter -----	Q6202 emitter -----	12
Q6204 emitter -----	Q6202 base -----	400
Q6204 emitter -----	Q6202 collector -----	Infinity
Q6204 emitter -----	Q6203 emitter -----	250
Q6204 emitter -----	Q6203 base -----	Infinity
Q6204 emitter -----	Q6204 collector -----	Infinity

5-13. Battery Discharger Voltage Test Points

Perform the voltage checks given in the chart below on the battery discharger with Voltmeter, Electronic AN/USM-98. In all cases, the negative lead of the voltmeter is connected to the negative side of large load resistor R6208. Connect the battery discharger power connector to the test cable (para 5-2h), Connect pins 4 and 5 of the test cable to the positive terminal of Charger, Battery PP-1659/G (power supply), and con-

nect pins 2 and 7 to the negative terminal. Adjust the PP-1659/G for 8-volt dc output.

Positive prod test point	Indication (volts dc)
Q6201 emitter -----	+2.9
Q6201 base -----	+2.5
Q6201 collector -----	+8.0
Q6202 emitter -----	+2.9
Q6202 base -----	+3.4
Q6202 collector -----	+6.3
Q6203 emitter -----	+7.4
Q6203 base -----	+6.3
Q6203 collector -----	+1.0
Q6204 base -----	+1.0
Q6204 collector -----	+4.9
Junction of CR6201 and R6202.	+3.7



## CHAPTER 6

### REPAIRS AND ADJUSTMENTS

---

#### Section I. REPAIRS

##### 6-1. General Parts Replacement Techniques

When the battery charger chassis is removed from its case (para 6-2). The front panel detached from the chassis (para 6-4), and the printed circuit board removed from its socket connector (para 6-3), all components of the battery charger are easily accessible for repair or replacement. Follow the procedures given in paragraphs 6-5 and 6-6 to reach the battery discharger components. Precautions given below apply to general parts replacement.

a. Remove and install components that are soldered with a pencil-type soldering iron with a 25-watt maximum capacity. The battery charger is transistorized; if the soldering iron must be used with ac voltage, use an isolating transformer between the soldering iron and the line. Do *not* use a soldering gun; damaging voltages can be induced in the circuit components.

b. Before a part is unsoldered, note the position of the leads. If a part, such as a transformer or switch, has a number of connections, tag each of the leads to make proper connections when replacing the part. Be careful not to damage other leads by pulling or pushing them out of the way.

c. When soldering transistor leads, solder quickly; wherever wiring permits, use a heat sink (such as a long-nosed pliers) between the soldered joint and the transistor. Use the same length and dress of transistor leads as used originally.

d. Make well soldered connections; a carelessly soldered joint may create a new trouble, and is one of the most difficult troubles to isolate. Be careful not to allow drops of

solder to fall into the equipment; this action may cause short circuits.

e. Remove the 8-lead operational amplifiers and the 6-lead differential comparators as follows:

- (1) Use just enough heat at a lead to cause the solder to flow.
- (2) Quickly pump the solder into a teflon-tipped solder pump; remove as much solder as possible. Do this for each lead, and parts can easily be removed.

##### 6-2. Removal and Installation of Battery Charger Chassis

a. Remove the battery charger chassis from its case as follows:

- (1) Unlatch the two front latches and open the cover of the case.
- (2) Turn the case so that the front panels of the battery charger and the battery discharger chassis face the front.
- (3) Uncoil the input power cable from its retaining brackets in the cover of the case.
- (4) Remove the seven screws on the back of the case.
- (5) Remove the seven screws around the perimeter of the front panel.
- (6) Grasp the handles of the front panel of the battery charger and carefully pull the chassis out of the case.

b. Install the battery charger chassis in its case as follows:

- (1) Carefully slide the chassis into the case.

- (2) Align the screw holes in the case with the captive nuts on the chassis.
- (3) Install the seven screws around the perimeter of the front panel; do not tighten them.
- (4) Install the seven screws on the back of the case; do not tighten them.
- (5) Tighten the center screw on the back of the case; then tighten the remaining six screws.
- (6) Tighten the seven screws around the perimeter of the front panel.
- (7) Coil the input power cable in its retaining brackets in the cover of the case.
- (8) Close the cover of the case and latch it.

### 6-3. Removal and Replacement of Printed Circuit Board from Battery Charger Chassis

a. To remove the printed circuit board, first remove the chassis from its case (para 6-2a). The printed circuit board is attached to the retaining bar by six rivets. Remove the two screws which secure the retaining bar to the chassis and pull the retaining bar up; be careful not to damage the components of the printed circuit board.

b. To install the printed circuit board in the chassis, turn the printed circuit board so that the component side faces the back of the front panel. Carefully insert the printed circuit board connector as far as it will go into the socket connector in the chassis. Tighten the two screws that attach the retaining bar to the chassis.

### 6-4. Detaching and Attaching Battery Charger Front Panel

*Note.* Because of the front panel-to-chassis cabling, the front panel cannot be completely disconnected from the chassis without disconnecting the cabling terminations; however, to reach the components detach the front panel from the chassis and pull the panel as far away from the chassis as the cabling will allow. Six screws attach the front panel to the two angle brackets; these angle brackets are attached to the chassis by the four screws that are not tightened down completely into their locknuts. This condi-

tion permits the front panel to shift independently of the chassis, and minimizes the effects of shock and vibration. The front panel of the battery charger can be separated from the chassis for access to the components of the printed circuit board when it is installed in the chassis (for troubleshooting purposes), or components mounted on the front panel (for troubleshooting, repair, or replacement).

a. Detach the front panel from the chassis as follows:

- (1) Remove the chassis from its case.
- (2) Remove the six screws (three located in line with each handle) that attach the front panel to the angle brackets.
- (3) Carefully pull the top of the front panel forward and down as far as the panel-to-chassis cabling will allow without damaging the cable.
- (4) All components on the chassis, at the back of the front panel, and on the printed circuit board will be accessible.

b. Attach the front panel to the chassis as follows:

- (1) Carefully push the front panel back to the chassis; be careful not to crimp or damage the cabling.
- (2) Align the screw holes of the front panel with the captive nuts on the angle bracket, and install the screws located above each handle first; do not tighten them all the way. Install the remaining four screws. When all six screws are in place, tighten them securely.

### 6-5. Removal and Installation of Battery Discharger from Cover

a. Remove the battery discharger from the cover as follows:

- (1) Unlatch the two front latches, and open the cover of the case.
- (2) Unstrap the battery discharger input cable, and unclip it from the retaining clip.
- (3) Remove the four nuts, the lockwashers, and the flat washers that attach the perforated screen to the battery discharger chassis. Remove the perforated screen.

- (4) Remove the four large screws, the flat washers, and the shouldered washers located near the corners of the battery discharger chassis.
  - (5) Lift out the battery discharger chassis.
- b. Install the battery discharger in the cover as follows:
- (1) Insert the chassis into the cover; line up the screw holes in the chassis with the tapped holes in the cover.
  - (2) Install the four screws, the flat washers, and the shouldered washers that were removed (a (4) above).
  - (3) Insert the battery discharge input cable through the hole in the perforated screen.
  - (4) Install the perforated screen with the four nuts, the lockwashers, and the flat washers that were removed (a (3) above).
  - (5) Place the battery discharge input cable in its retaining clip, and fasten the harness that secures the connector.

## 6-6. Detaching and Attaching Battery Discharger Front Panel

- a. Detach the front panel and expose the components of the battery discharger chassis as follows:
- (1) Perform the procedures given in paragraphs 6-5 a (1), (2), and (3).
  - (2) Remove the screw, the lockwasher, and the flat washer located at each corner of the battery discharger faceplate.
  - (3) Carefully pull out the faceplate to expose the components of the chassis.
- b. Attach the front panel to the chassis as follows:
- (1) Replace the screws, the lockwashers, and the flat washers that were removed (a (2) above).
  - (2) Install the perforated screen with the nuts, the lockwashers, and the flat washers that were removed (para 6-5 a (3)).
  - (3) Place the battery discharge input cable in its retaining clip and fasten the harness that secures the connector.

## Section II. ADJUSTMENTS

### 6-7. Charging Current Adjustment

(fig. 6-1)

Perform the procedures given below to adjust the charging current to  $6 \pm 0.5$  amperes.

a. *Test Equipment Required.*

- (1) Test cable (para 5-2h).
- (2) Resistor, variable 0- to 7.5-ohm, 1,000-watt.

b. *Procedure.*

**Note.** This procedure is presented to adjust R6113 of the battery A charging current control circuit. If R6132 of the battery B charging current control circuit is to be adjusted, substitute the battery B controls, indicators, and connector for those called out in this procedure.

- (1) Open the PP-4127/U and remove the battery charger chassis from the case (para 6-2) to reach the adjust-

ment potentiometers at the top of the printed circuit board retaining bar.

- (2) Set up the equipment as shown in figure 6-1. For this adjustment procedure, set the 0- to 7.5-ohm, 1,000-watt resistor, variable for 1.5 ohm.
- (3) Connect the AC POWER INPUT connector to a 115- to 230-volt, 60- or 400-cps input source.
- (4) Set the SELECTOR SWITCH to 115 V or 230 V, depending on the input source used.
- (5) Press power interlock switch S6005 down (fig. 5--3) and set the AC POWER switch to ON. Check to see that the POWER ON and CHARGE OFF indicator lights illuminate.

(6) Hold the RESET (A) switch down for approximately 4 seconds; then release it. Check to see that the CHARGE OFF indicator light extinguishes as the CHARGE ON indicator light illuminates.

(7) Adjust R6113 (marked R13 on the top of the printed circuit board retaining bar) until TEST METER (A) indicates  $6 \pm 0.5$  amperes.

**6-8. Charging Voltage-Sensing and Cutoff Circuit Adjustments**

(fig. 6-2)

Potentiometers R6109 (battery A) and R6154 (battery B) of the battery charger should be adjusted so that the battery charging current is automatically cut off when the battery charger voltage reaches  $8.1 \pm 0.1$  volts.

*a. Test Equipment Required.*

- (1) Power Supply PP-3940/G (power supply).
- (2) Voltmeter, Electronic AN/USM-98 (electronic voltmeter).
- (3) Test cable (para 5-2 h),

*b. Procedure.*

- (1) This procedure is presented to adjust R6109

of the battery A charging voltage-sensing and cutoff circuit. If R6154 of the battery B charging voltage-sensing and cutoff circuit is to be adjusted, substitute the battery B controls, indicators, and connector for those called out in this procedure.

(1) Open the PP-4127/U and remove the battery charger chassis from its case (para 6-2) to reach the adjustment potentiometers at the top of the printed circuit board retaining bar.

(2) Connect the test equipment as shown in figure 6-2.

(3) Using the coarse and fine potentiometers in the test setup, adjust the output of the power source to approximately 7.5 volts as measured on the digital voltmeter.

(4) Connect the AC POWER INPUT cable to a 115- or 230-volt, 60- or 400-cps input source.

(5) Set the SELECTOR SWITCH to 115 V or 230 V, depending on the input source used.

(6) Press power interlock switch S6005 (fig. 5-3) down and set the AC POWER switch to ON. Check to see that the POWER ON and CHARGE OFF indicator lights illuminate.

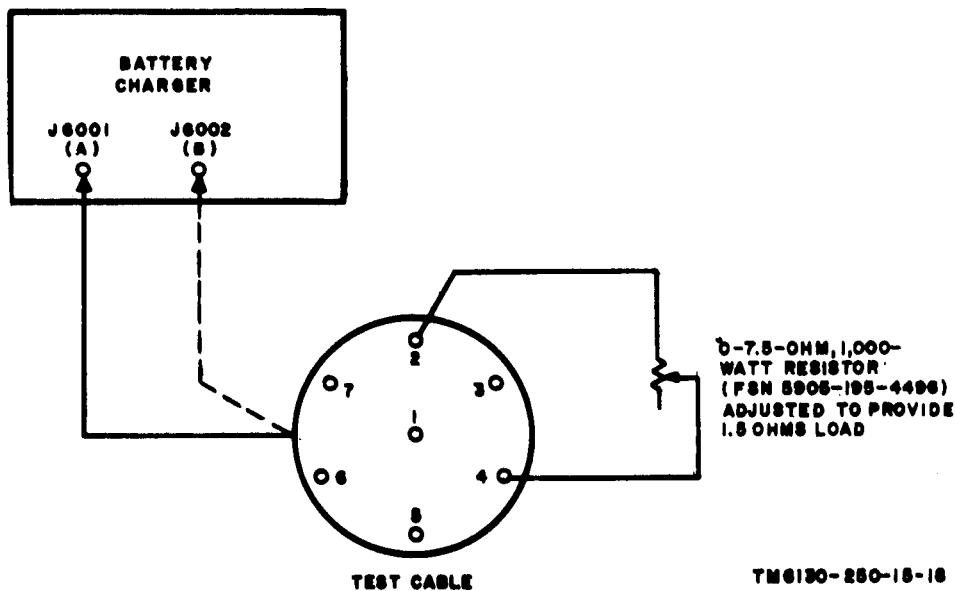

Figure 6-1. Test setup for adjusting battery charging current.

(7) Hold the RESET (A) switch down for approximately 4 seconds; then release it.

(8) Adjust the power supply output to 8.1 volts.

(9) Adjust potentiometer R6109 (marked R9 on the printed circuit board retaining bar) until the CHARGE OFF indicator light illuminates, as the CHARGE ON indicator light extinguishes.

(10) Recheck the setting of R6109 by adjusting the power supply output to 7.5 volts, and check to

see that the CHARGE ON indicator light illuminates and the CHARGE OFF indicator light extinguishes as the RESET (A) switch is actuated; then using the fine test potentiometer, slowly increase the test voltage and check to see that the cutoff circuitry operates when the test voltage is  $8.1 \pm 0.1$  volts. This condition may require several careful readjustments to obtain the desired  $8.1 \pm 0.1$  cutoff point; repeat the procedures given in (8), (9)

and (10; above as required, to obtain the correct setting of R6109.

**6-9. Battery Discharger Cutoff Circuit Adjustment**  
(fig. 6-3)

Potentiometer R6205 of the battery discharger

should be adjusted so that discharging of the battery will automatically be stopped when the battery potential reaches  $4.2 \pm 0.1$  volts.

*a. Test Equipment Required.*

- (1) Charger, Battery PP-1659/G (power supply).
- (2) Test cable (para 5-2h).

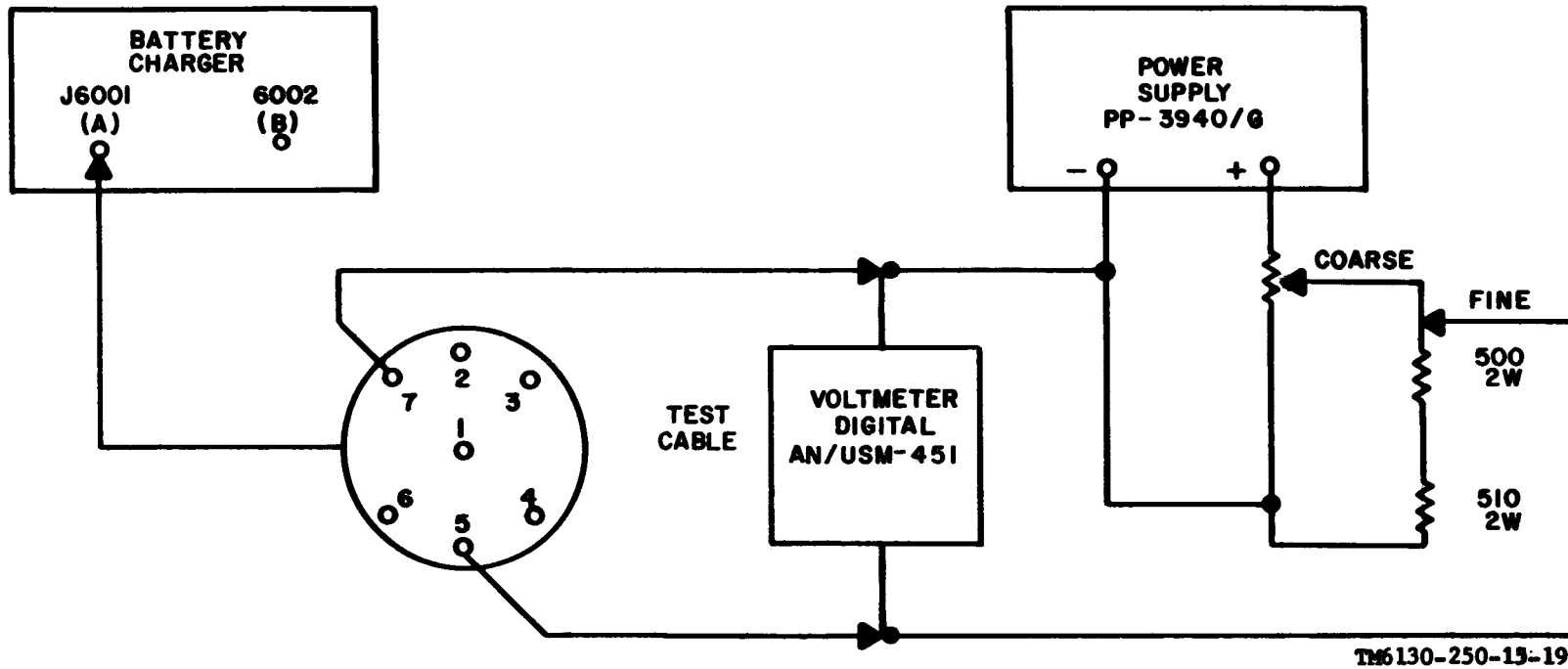
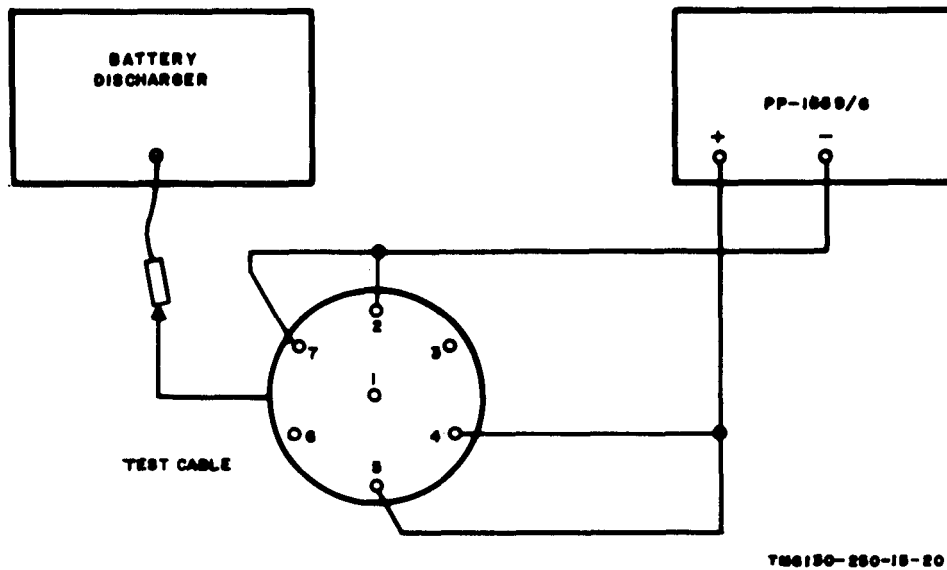

Figure 6-2. Test setup for adjusting battery discharger cutoff circuit.

*b. Procedure.*

- (1) Open the battery discharger to reach potentiometer R6205 (para 6-6).
- (2) Adjust R6205 fully counterclockwise.
- (3) Connect the equipment as shown in figure 6-3.
- (4) Adjust the PP-1659/G output for 8 volts.
- (5) Actuate the DISCHARGE switch, and check to see that the red DISCHARGE indicator light illuminates.
- (6) Slowly decrease the PP-1659/G output to 4.2 volts.
- (7) Adjust R6205 until the red DISCHARGE indicator light extinguishes.
- (8) Recheck the setting of R6205 by adjusting the PP-1659/G output to about 8 volts, actuating the DISCHARGE switch, and checking to see that the red DISCHARGE indicator light illuminates; then slowly decrease the output of the PP-1659/G and check to see that the red DISCHARGE indicator light extinguishes when the PP-1659/G output is  $4.2 \pm 0.1$  volts. This condition may require several touchup adjustment; repeat the procedures given in (6), (7), and (8) above, as required, to obtain the correct setting.



*Figure 6-3. Test setup for adjusting battery discharger cutoff circuit.*

CHAPTER 7

GENERAL SUPPORT TESTING PROCEDURES

**7-1. General**

a. Test procedures are prepared for use by Electronics Field Maintenance Shops and Electronics Service Organizations responsible for general support maintenance of electronic equipment to determine the acceptability of repaired equipment. These procedures set forth specific requirements that repaired equipment *must* meet before it is returned to the using organization. A summary of the performance standards is given in paragraph 7-8.

b. Comply with instructions preceding each chart before proceeding to the chart. Perform each step in

sequence. Do not vary the sequence. For each step, perform all actions required in the *Control settings* column; then perform each specific test procedure and verify it against its performance standard.

**7-2. Test Equipment, Tools, and Materials**

All test equipment, tools, and materials required to perform the test procedures given in this chapter are listed in *a*, *b*, and *c* below, and are authorized under TA 11-17. Some test equipment has been replaced and its replacement appears in the chart below. Use the replacement test equipment anytime the former test equipment is called for in this technical manual.

*a. Test Equipment.*

Nomenclature	Replaced by	Technical Manual
<b>Charger, Battery PP-1659/G</b>		TM 11-6130-238-12
<b>Power Supply PP-3940/G</b>		TM 11-6130-247-15
<b>Multimeter ME-87/U</b>	<b>Multimeter, ME-452/U</b>	
<b>Voltmeter, Electronic AN/USM-98</b>	<b>Multimeter, Digital AN/USM-451</b>	TM 11-6625-2953-14

b. *Tools.* All tools required are included in Tool Kit, Electronic Equipment TK-105/G.

(para 5-2h ) and the 0- to 7.5-ohm, 1,000-watt resistor, variable (FSN 5905-195-4496).

c. *Materials.* Materials required are the test cable

### 7-3. Physical Tests and Inspection

- a. *Test Equipment and Materials.* None required.
- b. *Test Connections and Conditions.*
  - (1) No connections necessary.
  - (2) Remove panels and covers as necessary for visual and actual access to all components.
- c. *Procedure.*

Step No.	Control settings		Test procedure	Performance standard
	Test equipment	Equipment under test		
1	None -----	Controls may be in any position.	<p>a. Inspect case and chassis for damage, missing parts, and condition of paint.</p> <p><i>Note.</i> Touchup painting is recommended instead of refinishing whenever practical; screw-heads, binding posts, receptacles, and other plated parts will not be painted or polished with abrasives.</p> <p>b. Inspect front panel for loose or missing screws.</p> <p>c. Inspect connectors, plug, meters, and handles for looseness or damage.</p> <p>d. Inspect rubber boots around CIRCUIT BREAKERS and toggle switches for looseness and wear.</p> <p>e. Inspect rubber seals and gaskets for proper seating.</p>	<p>a. No damage evident or parts missing. External surfaces to be painted do not show bare metal. Panel lettering is legible.</p> <p>b. All screws are tight; none are missing.</p> <p>c. No loose parts or damage.</p> <p>d. Boots are tight without cuts or holes.</p> <p>e. Gaskets and seals are securely fastened and properly seated.</p>
2	None -----	Controls may be in any position.	<p>a. Operate DISCHARGE, RESET (A), and RESET (B) switches.</p> <p>b. Loosen two screws and operate SELECTOR SWITCH.</p> <p>c. Operate AC POWER switch.</p>	<p>a. These spring-loaded switches return to their neutral position after being depressed.</p> <p>b. Switch operates properly.</p> <p>c. Switch operates properly.</p>





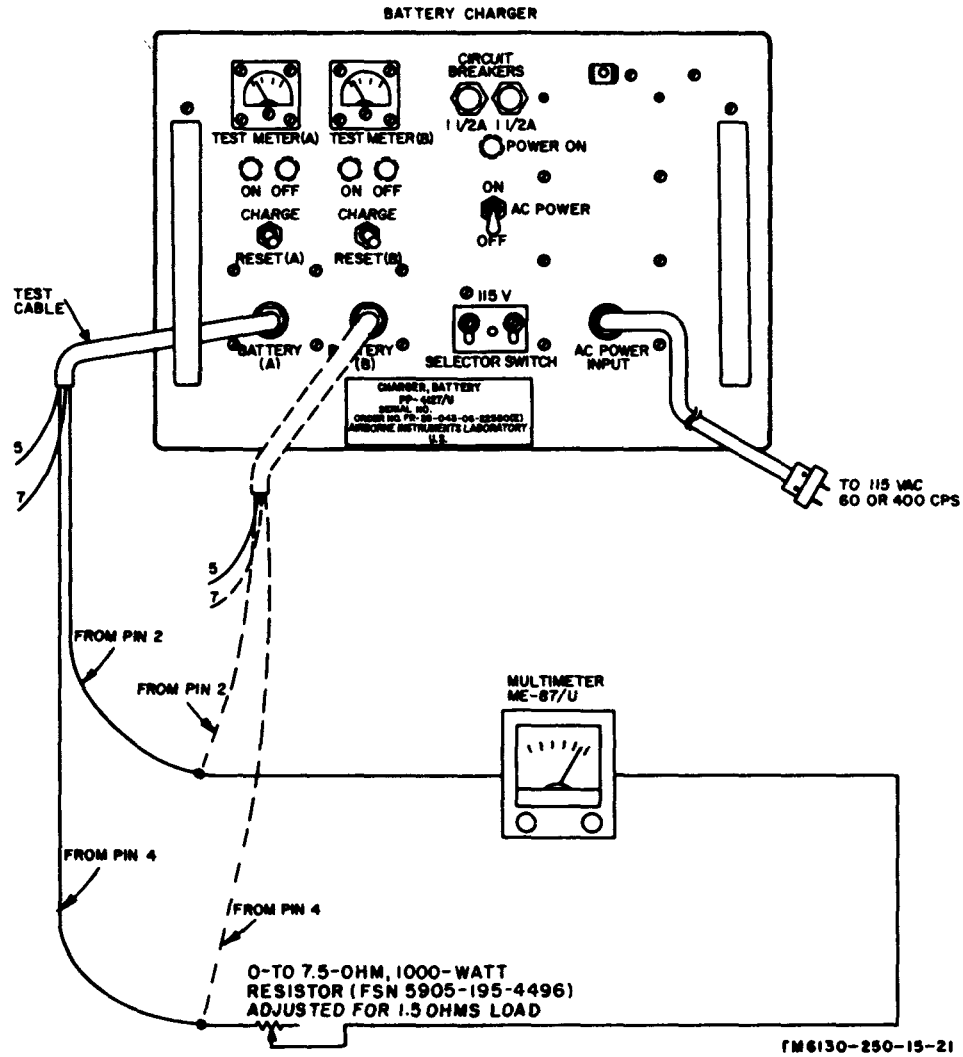

Figure 7-1. Charging current test, 115 volts ac, 60 or 400 cps.

**7-4. Charging Current Test, 115-volt ac, 60-or 400-cps Input**

*a. Test Equipment and Material.*

- (1) Multimeter ME-87/U.
- (2) Test Cable (para 5-2h).
- (3) Resistor, Variable, 0- to 7.5-ohm, 1000-watt.

*b. Test Connections and Conditions.* Connect the equipment as shown in figure 7-1. The resistor, variable (0- to 7.5-ohm) should be adjusted for a 1.5-ohm load resistance.

*c. Procedure.*

Step No.	Control settings		Test procedure	Performance standard
	Test equipment	Equipment under test		
1	ME-87/U Function: AMPS.	AC POWER switch: OFF. SELECTOR SWITCH: 115 V.	<ul style="list-style-type: none"> <li>a. Connect AC POWER INPUT cable to 115-volt, 60- or 400-cps power source.</li> <li>b. Set AC POWER switch to ON.</li> <li>c. Depress RESET (A) switch for 4 seconds; observe indication on ME-87/U and TEST METER (A).</li> <li>d. Set AC POWER switch to OFF.</li> </ul>	<ul style="list-style-type: none"> <li>a. None.</li> <li>b. POWER ON indicator light illuminates.</li> <li>c. CHARGE ON indicator light illuminates, and ME-87/U indicates <math>6 \pm 0.5</math> amperes. TEST METER (A) indicates within 3 percent of the indication on ME-87/U.</li> <li>d. POWER ON indicator light extinguishes.</li> </ul>
2	ME-87/U Function: AMPS.	AC POWER switch: OFF. SELECTOR SWITCH: 115 V.	<ul style="list-style-type: none"> <li>a. Connect test cable to BATTERY (B) connector.</li> <li>b. Set AC POWER switch to ON.</li> <li>c. Depress RESET (B) switch for 4 seconds; observe multimeter and TEST METER (B).</li> <li>d. Set AC POWER switch to OFF.</li> <li>e. Disconnect AC POWER INPUT cable from power source, and disconnect remainder of equipment.</li> </ul>	<ul style="list-style-type: none"> <li>a. None.</li> <li>b. POWER ON indicator light illuminates.</li> <li>c. CHARGE ON indicator light illuminates, and ME-87/U indicates <math>6 \pm 0.5</math> amperes. TEST METER (B) indicates within 3 percent of the indication on ME-87/U.</li> <li>d. POWER ON indicator light extinguishes.</li> <li>e. None.</li> </ul>

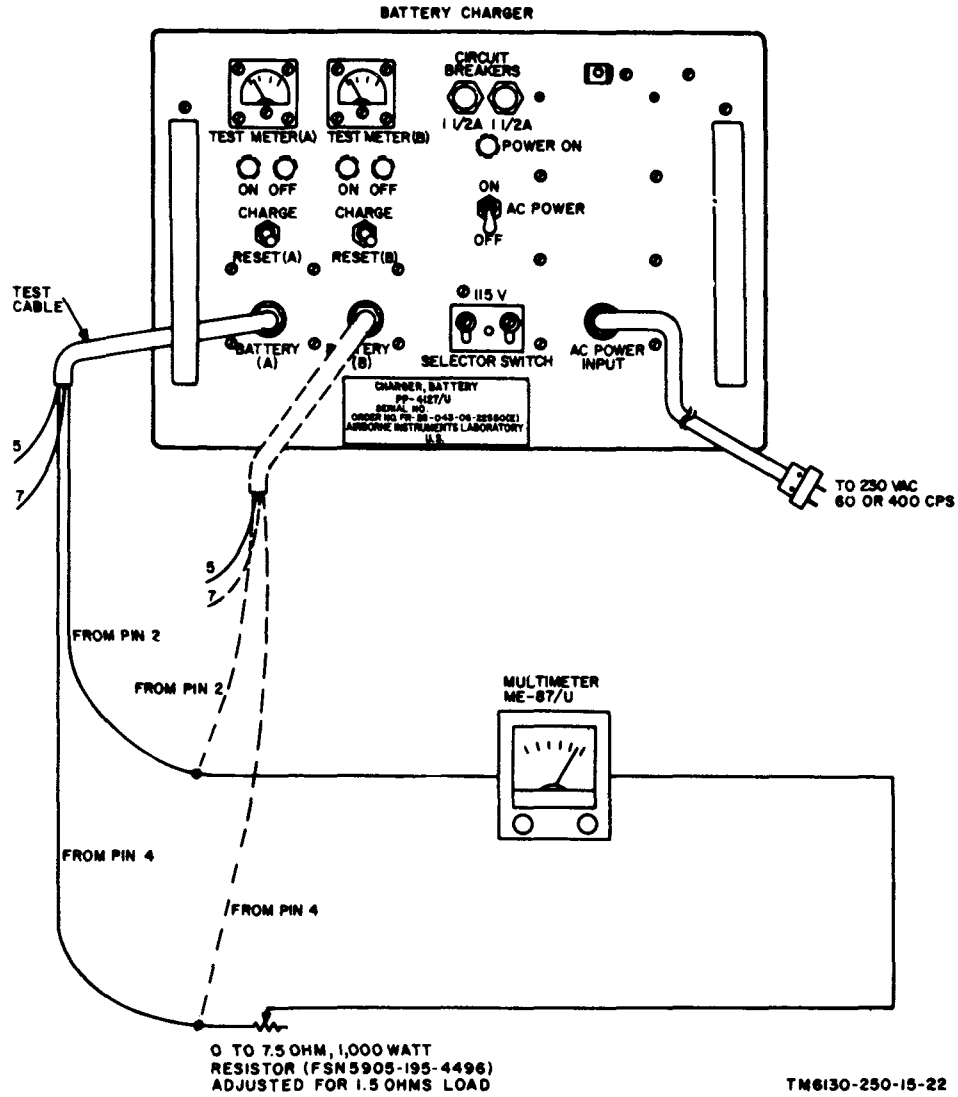

Figure 7-2. Charging current test, 230 volts ac, 60 or 400 cps.

### 7-5. Charging Current Test, 230-volt ac, 60- or 400-cps Input

a. *Test Equipment and Material.*

- (1) Multimeter ME-87/U.
- (2) Test cable (para 5-2h).
- (3) Resistor, Variable 0- to 7.5-ohm, 1,000-watt.

b. *Test Connections and Conditions.* Connect the equipment as shown in figure 7-2. The resistor, variable (0- to 7.5-ohm) should be adjusted for a 1.5-ohm load resistance.

c. *Procedure.*

Step No.	Control settings		Test procedure	Performance standard
	Test equipment	Equipment under test		
1	ME-87/U Function: AMPS.	AC POWER switch: OFF. SELECTOR SWITCH: 230 V.	<ul style="list-style-type: none"> <li>a. Connect AC POWER INPUT cable to a 230-volt, 60- or 400-cps power source.</li> <li>b. Set AC POWER switch to ON.</li> <li>c. Depress RESET (A) switch for 4 seconds; observe multimeter and TEST METER (A).</li> <li>d. Set AC POWER switch to OFF.</li> </ul>	<ul style="list-style-type: none"> <li>a. None.</li> <li>b. POWER ON indicator light illuminates.</li> <li>c. CHARGE ON indicator light illuminates and ME-87/U indicates <math>6 \pm 0.5</math> amperes. TEST METER (A) indicates within 3 percent of indication on ME-87/U.</li> <li>d. POWER ON indicator light extinguishes.</li> </ul>
2	ME-87/U Function: AMPS.	AC POWER switch: OFF. SELECTOR SWITCH: 230 V.	<ul style="list-style-type: none"> <li>a. Connect test cable to BATTERY (B) connector.</li> <li>b. Set AC POWER switch to ON.</li> <li>c. Depress RESET (B) switch for 4 seconds; observe multimeter and TEST METER (B).</li> <li>d. Set AC POWER switch to OFF.</li> <li>e. Disconnect AC POWER INPUT cable from power source, and disconnect remainder of equipment.</li> </ul>	<ul style="list-style-type: none"> <li>a. None.</li> <li>b. POWER ON indicator light illuminates.</li> <li>c. CHARGE ON indicator light illuminates and ME-87/U indicates <math>6 \pm 0.5</math> amperes. TEST METER (B) indicates within 3 percent of indication on ME-87/U.</li> <li>d. POWER ON indicator light extinguishes.</li> <li>e. None.</li> </ul>

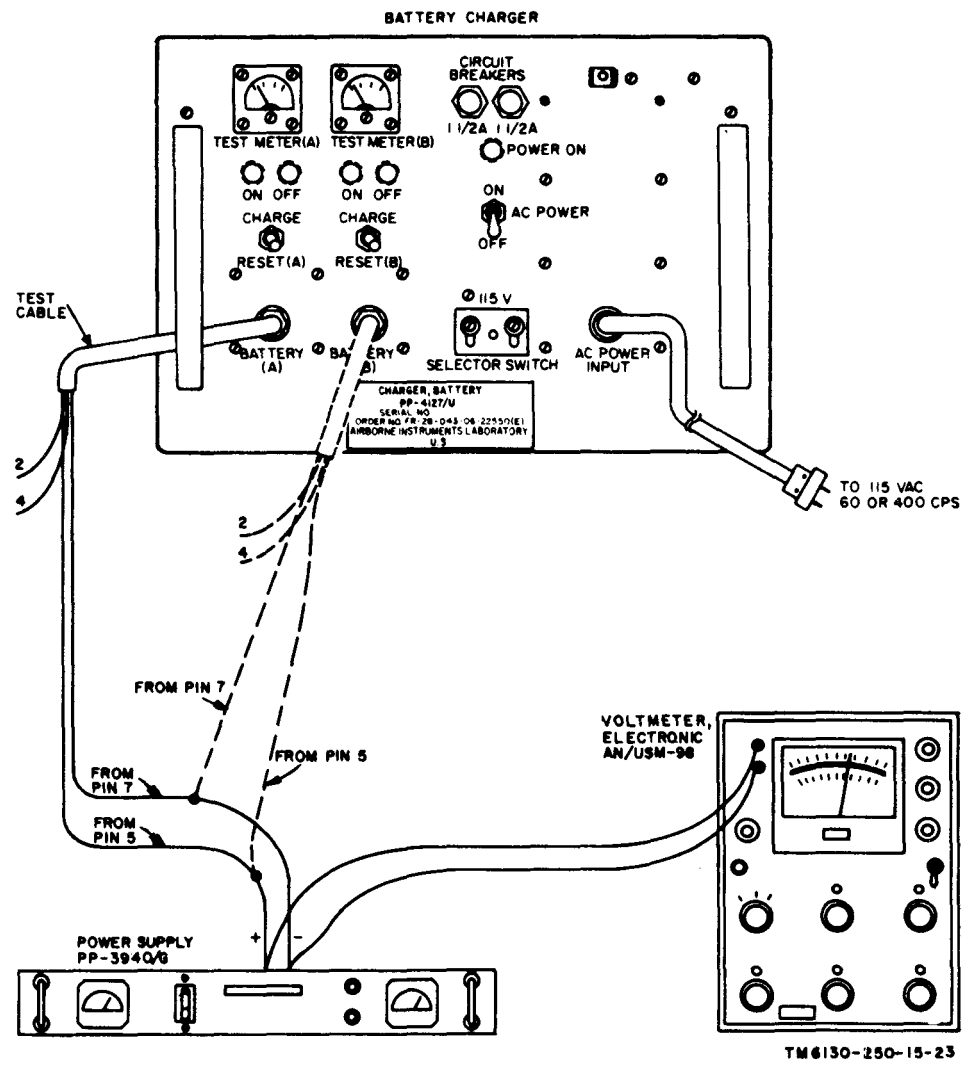

Figure 7-3. Charging voltage cutoff test.

**7-6. Charging Voltage Cutoff Test**

**a. Test Equipment and Material.**

- (1) Power Supply PP-3940/G.
- (2) Voltmeter, Electronic AN/USM-98.
- (3) Test cable (para 5-2h).

**b. Test Connections and Conditions.** Connect the equipment as shown in figure 7-3.

**c. Procedure.**

Step No.	Control settings		Test procedure	Performance standard
	Test equipment	Equipment under test		
1	<p><i>PP-3940/G</i>                      COARSE ADJ: Fully counterclockwise.                      FINE ADJ: Fully counterclockwise.  <i>AN/USM-98</i>                      VOLTS RANGE: 50.                      NULL: VTVM.</p>	<p>AC POWER switch: OFF                      SELECTOR SWITCH: 115 V.</p>	<p>a. Connect AC POWER INPUT cable to a 115-volt, 60- or 400-cps power source.                      b. Set AC POWER switch to ON.                      c. Depress RESET (A) switch for 4 seconds.                      d. Adjust COARSE ADJ and FINE ADJ controls on PP-3940/G until CHARGE ON indicator light extinguishes and CHARGE OFF indicator light illuminates; observe indication on AN/USM-98.                      e. Set AC POWER switch to OFF.</p>	<p>a. None.                      b. POWER ON indicator light illuminates.                      c. CHARGE ON indicator light illuminates.                      d. AN/USM-98 indicates between 7.9 and 8.2 volts when CHARGE ON indicator light extinguishes.                      e. POWER ON indicator light extinguishes.</p>
2	<p>Same as step 1 -----</p>	<p>AC POWER switch: OFF                      SELECTOR SWITCH: 115 V.</p>	<p>a. Connect test cable to BATTERY (B) connector.                      b. Set AC POWER switch to ON.                      c. Depress RESET (B) switch for 4 seconds.                      d. Adjust COARSE ADJ and FINE ADJ controls on PP-3940/G until CHARGE ON indicator light extinguishes and the CHARGE OFF indicator light illuminates; observe indication on AN/USM-98.                      e. Set AC POWER switch to OFF.                      f. Disconnect AC POWER INPUT cable from power source, and disconnect remainder of equipment.</p>	<p>a. None.                      b. POWER ON indicator light illuminates.                      c. CHARGE ON indicator light illuminates.                      d. AN/USM-98 indicates between 7.9 and 8.2 volts when CHARGE ON indicator light extinguishes.                      e. Power ON indicator light extinguishes.                      f. None.</p>

Figure 7-4, page 7-10 deleted.

Change 3 7-9/(7-10 blank)

■ Paragraph 7-7 deleted.

**7-8. Test Data Summary**

- a. Charging current. . . . . $6\pm 0.5$  amperes.
- b. Charging voltage cutoff. . . . . $8.1\pm 0.1$  volts.

■ c. Deleted.



**7-7. Discharging Voltage Cutoff Test**

*a. Test Equipment and Materials.*

- (1) Battery Charger, PP-1659/G.
- (2) Voltmeter, Electronic AN/USM-98.
- (3) Test cable (para 5-2h).

*b Test Connections and Conditions.* Connect the equipment as shown in figure 7-4.

*c. Procedure.*

Step No.	Control settings		Test procedure	Performance standard
	Test equipment	Equipment under test		
1	<p><i>PP-1659/G</i> Set to provide approximately 8 volts. <i>AN/USM-98</i> VOLTS RANGE: 50. NULL: VTVM.</p>	None -----	<p>1. Press DISCHARGE switch down. b. Decrease voltage on PP-1659/G until DISCHARGE indicator light extinguishes; observe indication on AN/USM-98. c. Turn off and disconnect equipment.</p>	<p>a. DISCHARGE indicator light illuminates. b. AN/USM-98 indicates between 4.1 and 4.3 volts when DISCHARGE indicator light extinguishes. c. None.</p>

**7-8. Test Data Summary**

- a. Charging current -----6 ±0.5 amperes.
- b. Charging voltage cutoff--8.1 ±0.1 volts.
- c. Discharging voltage cutoff.4.1 ±0.1 volts.



## CHAPTER 8

### DEPOT OVERHAUL STANDARDS

---

#### **8-1. Applicability of Depot Overhaul Standards**

Tests outlined in this chapter are designed to measure the performance capability of a repaired equipment. Equipment that is to be returned to stock should meet standards given in these tests.

#### **8-2. Applicable References**

*a. Repair Standards.* Applicable procedures of depots which perform these tests, and the general standards for repaired electronic equipment given in TB SIG 355-1, TB SIG 355-2, and TB SIG 355-3 form a part of requirements for testing this equipment.

*b. Modification Work Orders.* Perform

all modification work orders applicable to this equipment before making tests specified. DA Pam 310-4 lists all available MWO'S.

#### **8-3. Test Facilities Required**

Items required for depot testing are the same as those given in paragraph 7-2.

#### **8--4. Tests**

The depot inspection standards test procedures are the same as those given for general support (paras 7-4 through 7.6). Equipment that meets the performance standards stated in these tests will furnish satisfactory operation equivalent to that of new equipment.



## CHAPTER 9

### SHIPMENT, LIMITED STORAGE, AND DEMOLITION TO PREVENT ENEMY USE

---

#### 9-1. Packaging for Shipment

The exact procedure for packaging the equipment for shipment and storage depends on materials available and conditions under which the equipment is to be shipped or stored. If the original packaging materials are available, package the equipment as shown in figure 2-1. If the original packaging materials are not available, use sturdy cartons and barrier material to protect the equipment.

#### 9-2. Authority for Demolition

Demolition of the equipment will be accomplished only upon order of the commander. The destruction procedures given in paragraph 9-3 will be used to prevent further use of the equipment

#### 9-3. Methods of Demolition

Use any of the methods of destruction given below. The time available for destruction is the major factor in determining the method of destruction.

*a. Smash.* Smash the cabinet, meters, and controls. Use sledges, axes, hammers, crow-bars, and other heavy tool available. Remove the top panel, and smash the internal components.

*b. Cut.* Cut the wiring of the PP-4127/U. Use axes, handaxes, or machetes.

**Warning: Be extremely careful with explosives and incendiary devices. Use these items only when the need is urgent.**

*c. Burn.* Burn the technical manuals first. Burn as much of the equipment as is flammable; use gasoline, oil, flamethrowers, and similar materials. Pour gasoline on the cut cables and internal wiring and ignite them. Use a flamethrower to burn the spare parts, or pour gasoline on spares and ignite them. Use incendiary grenades to complete the destruction of the unit.

*d. Dispose.* Bury or scatter destroyed parts, or throw them into nearby waterways.

COLOR CODE MARKING FOR MILITARY STANDARD RESISTORS

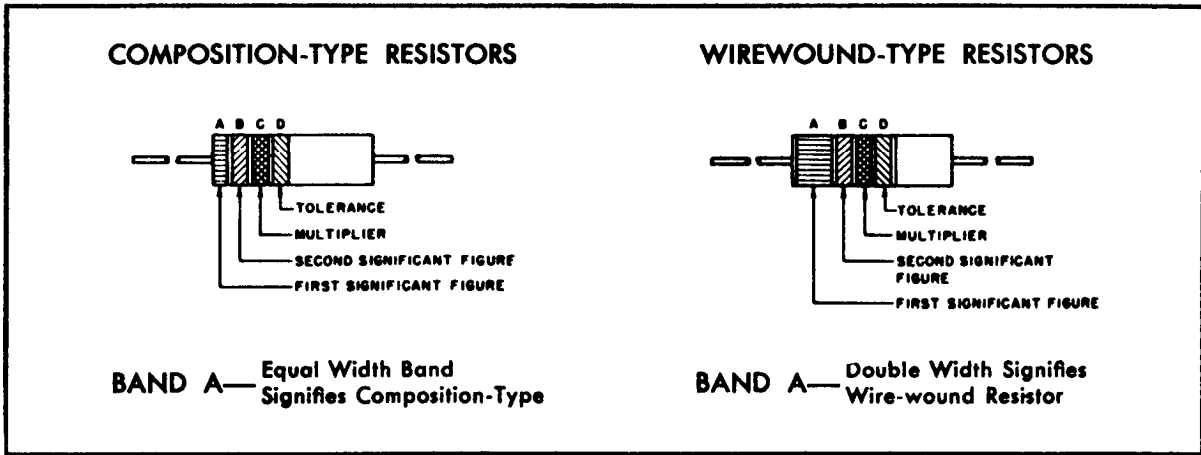

COLOR CODE TABLE

BAND A		BAND B		BAND C		BAND D*	
COLOR	FIRST SIGNIFICANT FIGURE	COLOR	SECOND SIGNIFICANT FIGURE	COLOR	MULTIPLIER	COLOR	RESISTANCE TOLERANCE (PERCENT)
BLACK	0	BLACK	0	BLACK	1		
BROWN	1	BROWN	1	BROWN	10		
RED	2	RED	2	RED	100		
ORANGE	3	ORANGE	3	ORANGE	1,000		
YELLOW	4	YELLOW	4	YELLOW	10,000	SILVER	± 10
GREEN	5	GREEN	5	GREEN	100,000	GOLD	± 5
BLUE	6	BLUE	6	BLUE	1,000,000		
PURPLE (VIOLET)	7	PURPLE (VIOLET)	7				
GRAY	8	GRAY	8	SILVER	0.01		
WHITE	9	WHITE	9	GOLD	0.1		

EXAMPLES OF COLOR CODING

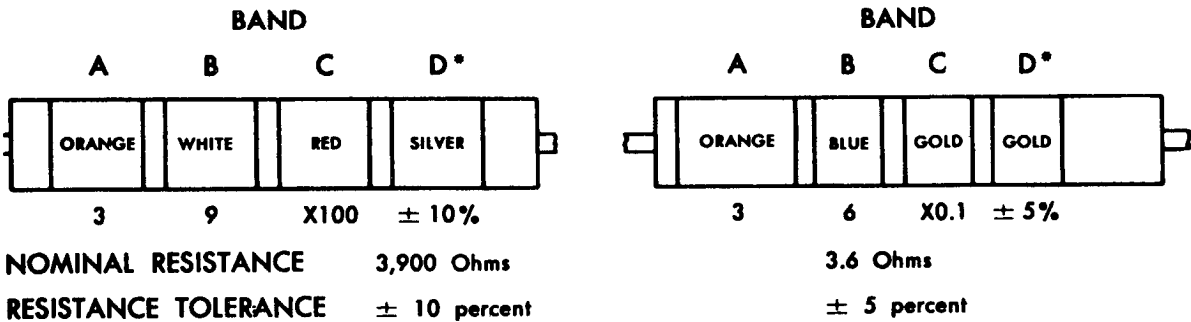

STD-R2

\*If Band D is omitted, the resistor tolerance is ± 20%, and the resistor is not Mil-Std.

Figure 9-1. MIL-STD resistor color code markings.

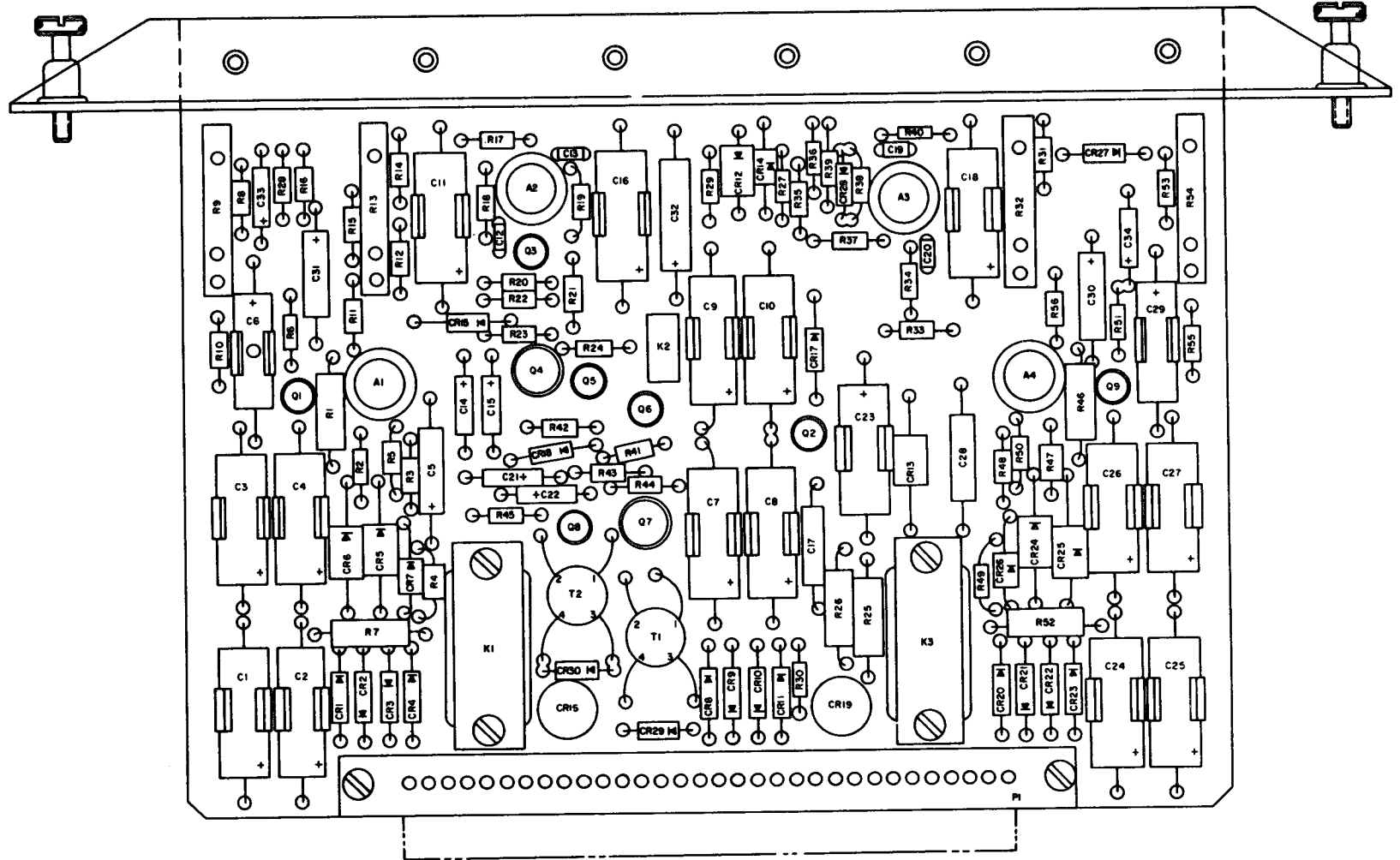

NOTE: ADD 6400 TO ALL REFERENCE DESIGNATIONS

TM6130-250-15-14

Figure 9-3. Battery charger printed circuit board component locations.





## APPENDIX A

### REFERENCES

---

<p><b>AR 735-11-2</b> DA Pam 310-4 TA 11-17 TB 43-0118</p>	<p>Reporting of Item and Packaging Discrepancies. Index of Technical Publications. Army Field Maintenance Shops. Field Instructions for Painting and Preserving Electronics Command Equipment Including Camouflage Pattern Painting of Electrical Equipment Shelters.</p>
<p>TB SIG 355-1 TB SIG 355-2 TB SIG 355-3 TM 11-6130-238-14</p>	<p>Depot Inspection Standard for Repaired Signal Equipment. Depot Inspection Standard for Refinishing Repaired Signal Equipment. Depot Inspection Standard for Moisture and Fungus Resistant Treatment. Operator's Organizational, Direct Support, and General Support Maintenance Manual for Charger, Battery PP-1659/G and PP-1659A/G (NSN 6190-00-985-8185).</p>
<p>TM 11-6130-247-15</p>	<p>Operator's Organizational, Direct Support, General Support, and Depot Maintenance Manual for Power Supply PP-3940/G.</p>
<p>TM 11-6625-203-12</p>	<p>Operator and Organizational Maintenance Manual: Multimeters AN/URM-105 and AN/URM-105C (Including Multimeters ME-77/U and ME-77C/U).</p>
<p>TM 11-6625-539-15</p>	<p>Operator's Organizational, Field and Depot Maintenance Manual for Transistor Set TS-1836/U.</p>
<p>TM 11-6625-654-14</p>	<p>Operator's Organizational, Direct Support, and General Support Maintenance Repair Parts and Special Tools List (Including Depot Maintenance Repair Parts and Special Tools List) for Multimeter, AN/USM-223.</p>
<p>TM 11-6625-1703-15</p>	<p>Operator's, Organizational, Direct Support, General Support, and Depot Maintenance Manual: Oscilloscope AN/USM-281A (NSN 6625-00-228-2201).</p>
<p>TM 11-6625-2639-14</p>	<p>Operator's Organizational, Direct Support, and General Support Maintenance Manual Including Repair Parts and Special Tools Lists (Including Depot Maintenance Repair Parts and Special Tools): Bridge, Capacitance, Inductance, and Resistance ZM-71/U.</p>
<p>TM 11-6625-2953-14</p>	<p>Operator's Organizational, Direct Support and General Support Maintenance Manual, Multimeter, AN/USM-451 (NSN 6625-01-060-6804).</p>
<p>TM 38-750</p>	<p>The Army Maintenance Management System (TAMMS).</p>



# APPENDIX C

## MAINTENANCE ALLOCATION

---

### Section I. INTRODUCTION

#### C-1. General

This appendix provides a summary of the maintenance operations for the PPO4127/U. It authorizes categories of maintenance for specific maintenance functions on repairable items and components and the tools and equipment required to perform each function. This appendix may be used as an aid in planning maintenance operations.

#### C-2. Maintenance Function

Maintenance functions will be limited to and defined as follows

*a. Inspect.* To determine the serviceability of an item by comparing its physical, mechanical, and/or electrical characteristics with established standards through examination.

*b. Test.* To verify serviceability and to detect incipient failure by measuring the mechanical or electrical characteristics of an item and comparing those characteristics with prescribed standards.

*c. Service.* Operations required periodically to keep an item in proper operating condition, i.e., to clean (decontaminate), to preserve, to drain, to paint, or to replenish fuel, lubricants, hydraulic fluids, or compressed air supplies.

*d. Adjust.* To maintain, within prescribed limits, by bringing into proper or exact position, or by setting the operating characteristics to the specified parameters.

*e. Align.* To adjust specified variable elements of an item to bring about optimum or desired performance.

*f. Calibrate.* To determine and cause corrections to be made or to be adjusted on instruments or test measuring and diagnostic equipments used in precision measurement. Consists of comparisons of two instruments, one of which is a certified standard of known accuracy, to detect and adjust any discrepancy in the accuracy of the instrument being compared.

*g. Install.* The act of emplacing, seating, or fixing into position an item, part, module (component or assembly) in a manner to allow the proper functioning of the equipment or system.

*h. Replace.* The act of substituting a serviceable like type part, subassembly, or module (component

or assembly) for an unserviceable counterpart.

*i. Repair.* The application of maintenance services (inspect, test, service, adjust, align, calibrate, replace) or other maintenance actions (welding, grinding, riveting, straightening, facing, remachining, or resurfacing) to restore serviceability to an item by correcting specific damage, fault, malfunction, or failure in a part, subassembly, module (component or assembly), end item, or system.

*j. Overhaul.* That maintenance effort (service/action) necessary to restore an item to a completely serviceable/operational condition as prescribed by maintenance standards (i.e., DMWR) in appropriate technical publications. Overhaul is normally the highest degree of maintenance performed by the Army. Overhaul does not normally return an item to like new condition.

*k. Rebuild.* Consists of those services/actions necessary for the restoration of unserviceable equipment to a like new condition in accordance with original manufacturing standards. Rebuild is the highest degree of materiel maintenance applied to Army equipment. The rebuild operation includes the act of returning to zero those age measurements (hours, miles, etc.) considered in classifying Army equipments/components.

#### C-3. Column Entries

*a. Column 1, Group Number.* Column 1 lists group numbers, the purpose of which is to identify components, assemblies, subassemblies, and modules with the next higher assembly.

*b. Column 2, Component/Assembly.* Column 2 contains the noun names of components, assemblies, subassemblies, and modules for which maintenance is authorized.

*c. Column 3, Maintenance Functions.* Column 3 lists the functions to be performed on the item listed in column 2. When items are listed without maintenance functions, it is solely for purpose of having the group numbers in the MAC and RPSTL coincide.

*d. Column 4, Maintenance Category.* Column 4 specifies, by the listing of a "work timed" figure in the appropriate subcolumn(s), the lowest level of

maintenance authorized to perform the function listed in column 3. This figure represents the active time required to perform that maintenance function at the indicated category of maintenance. If the number or complexity of the tasks within the listed maintenance function vary at different maintenance categories, appropriate "work time" figures will be shown for each category. The number of task-hours specified by the "work time" figure represents the average time required to restore an item (assembly, subassembly, component, module, end item or system) to a serviceable condition under typical field operating conditions. This time includes preparation, troubleshooting time, and quality assurance/quality control time in addition to the time required to perform the specific tasks identified for the maintenance functions authorized in the maintenance allocation chart. Subcolumns of column 4 areas follows:

- C-Operator/Crew
- O-Organizational
- F-Direct Support
- H-General Support
- D-Depot

e. *Column 5, Tools and Equipment.* Column 5 specifies by code, those common tool sets (not individual tools) and special tools, test, and support equipment required to perform the designated function.

f. *Column 6, Remarks.* Column 6 contains an alphabetic code which leads to the remark in section

a. *Tool or Test Equipment Reference Code.* The numbers in this column coincide with the numbers used in the tools and equipment column of the MAC. The numbers indicate the applicable tool or test equipment for the maintenance functions.

h. *Maintenance Category.* The codes in this column indicate the maintenance category allocated the tool or test equipment.

c. *Nomenclature.* This column lists the noun name and nomenclature of the tools and test equipment required to perform the maintenance functions.

d. *National/NATO Stock Number.* This column lists the National/NATO stock number of the specific tool or test equipment.

e. *Tool Number.* This column lists the manufacturer's part number of the tool followed by the Federal Supply Code for manufacturers (5-digit) in parentheses.

#### **C-5. Remarks (Sect. IV)**

a. *Reference Code.* This code refers to the appropriate item in section II, column 6.

h. *Remarks.* This column provides the required explanatory information necessary to clarify items appearing in section II.

(Next printed page is C-3)

SECTION II MAINTENANCE ALLOCATION CHART  
FOR

CHARGER, BATTERY PP-4127( )/U

(1) GROUP NUMBER	(2) COMPONENT/ASSEMBLY	(3) MAINTENANCE FUNCTION	(4) CATEGORY					(5) TOOLS AND EQPT.	(6) REMARKS
			C	O	F	H	D		
00	CHARGER, BATTERY PP-4127( )/U	Inspect Service Test Repair Test Adjust Repair Test Repair Overhaul	1 1	1 2	.0 .2 .0	.0 .0		thru 11 thru 5 thru 14 4, 5 thru 15	A B C D E D
01	CONTROL BOARD ASSEMBLY	Replace Test Repair			.2	.7 .0	18	thru 15	

Change 3 0-3

SECTION III TOOL AND TEST EQUIPMENT REQUIREMENTS  
FOR

CHARGER, BATTERY PP-4127( )/U

COLOR TEST EQUIPMENT REF CODE	MAINTENANCE CATEGORY	NOMENCLATURE	NATIONAL/NATO STOCK NUMBER	TOOL NUMBER
1	O	MULTIMETER, AN/URM-105	6625-00-581-2036	
2	O	TOOL KIT, ELECTRONIC EQUIPMENT TK-101/G	6180-00-064-5178	
3	F,H,D	TOOL KIT, ELECTRONIC EQUIPMENT TK-105/G	6180-00-610-8177	
4	F,H,D	TOOL, INSERTION: 11139; M15513, SM-B-609917	6120-00-858-1455	
5	F,H,D	TOOL, REMOVAL: 11139; M15515-20, SM-B-609918	6120-00-522-8601	
6	F,H,D	MULTIMETER, AN/USM-223/U (RS TS-352 B/U)	6625-00-999-7465	
7	F,H,D	OSCILLOSCOPE, AN/USM-281 C	6625-00-106-9622	
8	F,H,D	POWER SUPPLY, PP-3940 A/G	6130-00-460-2148	
9	F,H,D	TEST SET, SEMICONDUCTOR DEVICE TS-1836C/U	6625-00-138-7320	
10	F,H,D	BRIDGE, IMPEDANCE ZM-71/U	6625-00-236-1536	
11	F,H,D	VOLTMETER, ELECTRONIC ME-202( )/U	6625-00-709-0288	
12	H,D	MULTI METER, AN/ USM-451	6625-01-060-6804	
13	H,D	RESISTOR, VARIABLE 0-7 1/2Ω, 1000W	5905-00-195-4496	
14	H,D	TRANSFORMER, VARIABLE POWER TF-510/U	6120-00-054-7794	
15	H,D	CHARGER, BATTERY PP-4127( )/U	6130-00-928-1942	

SECTION IV. REMARKS

REFERENCE CODE	REMARKS
A	EXTERIOR
B	CONTINUITY OF POWER CABLES
C	POWER PLUG, KNOBS, LAMPS, LENS
D	ALL EXCEPT CONTROL CIRCUIT BOARD
E	VARIABLE RESISTORS





INDEX

	Paragraph	Page
Adjustment:		
Charging current -----	6-7	6-3
Charging voltage-sensing and cutoff circuit -----	6-8	6-4
Authority for demolition -----	9-2	9-1
Basic ac phase-controlled current regulator -----	4-1	4-1
Battery charger:		
Controls and indicators -----	2-4	2-3
Troubleshooting chart -----	5-5	5-8
Voltage test points -----	5-8	5-10
Battery charging:		
Circuit description -----	4-2	4-3
Procedures -----	2-8	2-6
Battery discharger:		
Operating control and indicator -----	2-5	2-6
Troubleshooting chart -----	5-11	5-14
Turn-on circuitry -----	4-3	4-6
Voltage-sensing and cutoff circuitry -----	4-4	4-6
Voltage test points -----	5-13	5-14
Battery discharging procedures -----	2-9	2-7
Charging current adjustment -----	6-7	6-3
Charging voltage-sensing and cutoff circuit adjustment -----	6-8	6-4
Checking unpacked equipment -----	2-2	2-1
Cleaning -----	3-8	3-3
Control and indicator, battery discharger -----	2-5	2-6
Controls and indicators, battery charger -----	2-4	2-3
Damage from improper setting -----	2-3	2-2
Dc resistance reading:		
Battery charger chassis -----	5-6	5-9
Battery discharger circuit -----	5-12	5-14
Printed circuit board -----	5-7	5-10
Depot overhaul standard:		
Applicability, depot overhaul standards -----	8-1	8-1
Applicable references -----	8-2	8-1
Test facilities required -----	8-3	8-1
Tests -----	8-4	8-1
Description, equipment -----	1-6	1-2
Detaching and attaching front panel:		
Battery charger -----	6-4	6-2
Battery discharger -----	6-6	6-3
Forms and records -----	1-3	1-1
General parts replacement techniques -----	6-1	6-1
General support test procedures:		
Charging current test:		
115-volt ac, 60- or 400-cps input -----	7-4	7-5
230-volt ac, 80- or 400-cps input -----	7-5	7-7
Charging voltage cutoff test -----	7-6	7-9

**TM 11-6130-250-15**

	<b>Paragraph</b>	<b>Page</b>
Discharging voltage cutoff test (deleted)		
General -----	7-1	7-1
Physical tests and inspection -----	7-3	7-2
Test data summary -----	7-8	7-11
Test equipment, tools, and materials -----	7-2	7-1
General troubleshooting instructions -----	5-1	5-1
Indexes, publications -----	1-2	1-1
Methods, demolition -----	9-3	9-1
Operator's daily preventive maintenance checks and services chart -----	3-4	3-1
Operator's weekly preventive maintenance checks and services chart -----	3-6	3-2
Organizational:		
Monthly preventive maintenance checks and services chart -----	3-6	3-2
Quarterly preventive maintenance checks and services chart -----	3-7	3-2
Troubleshooting chart -----	3-11	3-3
Troubleshooting information -----	3-10	3-3
Organizing troubleshooting procedure -----	5-2	5-1
Packaging, shipment -----	9-1	9-1
Preparation, troubleshoot battery discharger -----	5-10	5-14
Preventive maintenance -----	3-2	3-1
Preventive maintenance checks and services periods -----	3-3	3-1
Purpose and use -----	1-4	1-1
Removal and installation:		
Battery charger chassis -----	6-2	6-1
Battery discharger from cover -----	6-5	6-2
Removal and replacement, printed circuit board from battery charger chassis -----	6-3	6-2
Replacement, indicator lamps -----	3-12	3-4
Scope, operator and organizational maintenance -----	3-1	3-1
Scope, technical manual -----	1-1	1-1
SELECTOR SWITCH -----	2-6	2-6
Technical characteristics -----	1-6	1-2
Test equipment and materials required, troubleshooting -----	5-3	5-2
Touchup painting instructions -----	3-9	3-3
Troubleshooting test setup -----	5-4	5-8
Unpacking -----	2-1	2-1
Voltage-sensing cutoff circuit functioning -----	2-7	2-6
Waveform analysis -----	5-9	5-11

## COLOR CODE MARKING FOR MILITARY STANDARD CAPACITORS

### GROUP I Capacitors, Fixed, Various-Dielectrics, Styles CM, CN, CY, and CB

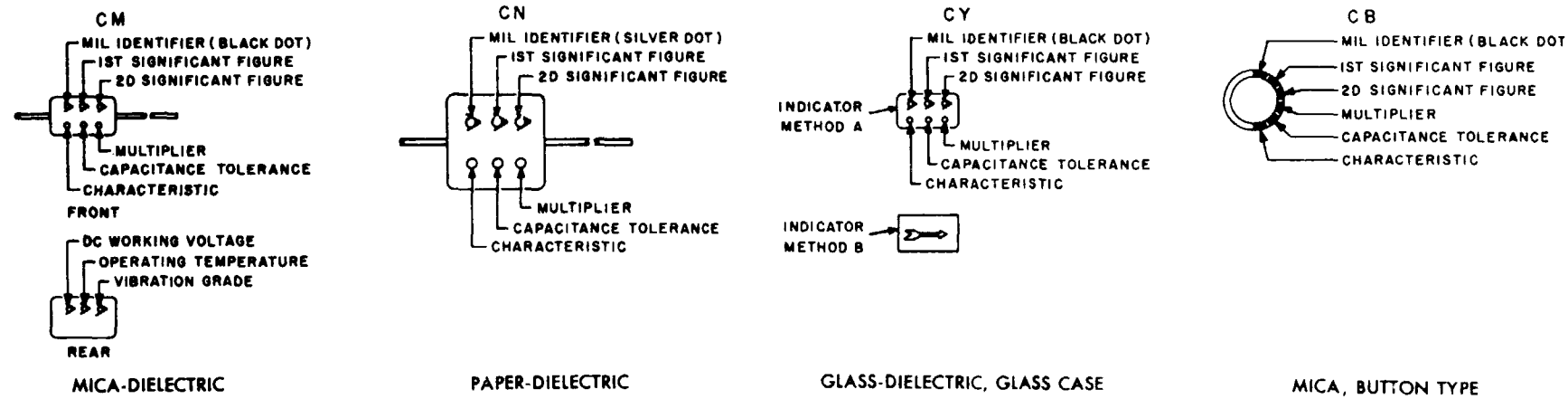

### GROUP II Capacitors, Fixed Ceramic-Dielectric (General Purpose) Style CK

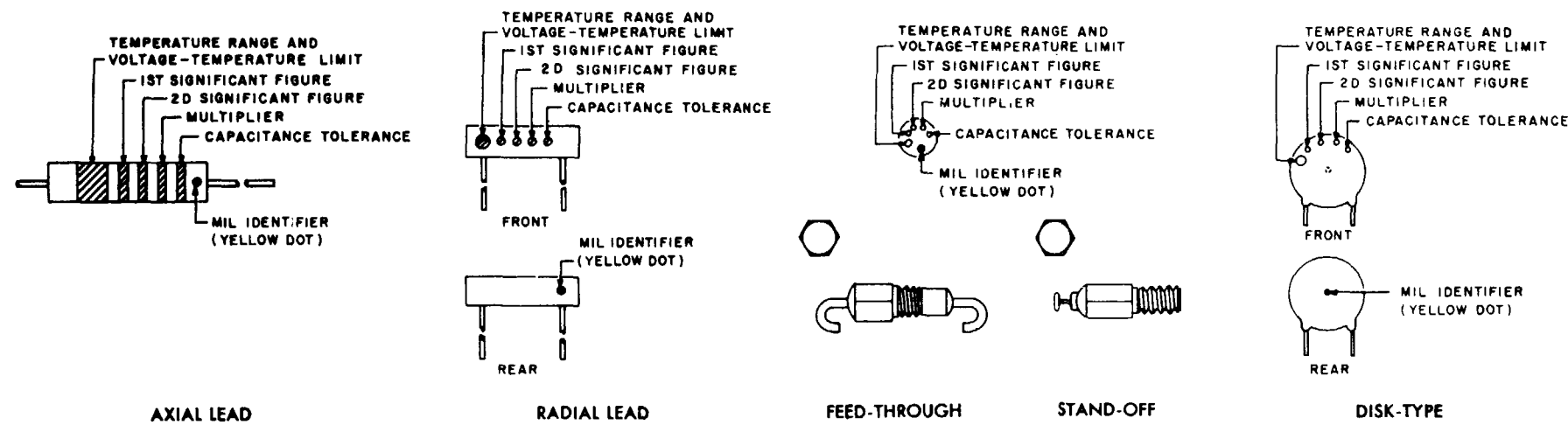

### GROUP III Capacitors, Fixed, Ceramic-Dielectric (Temperature Compensating) Style CC

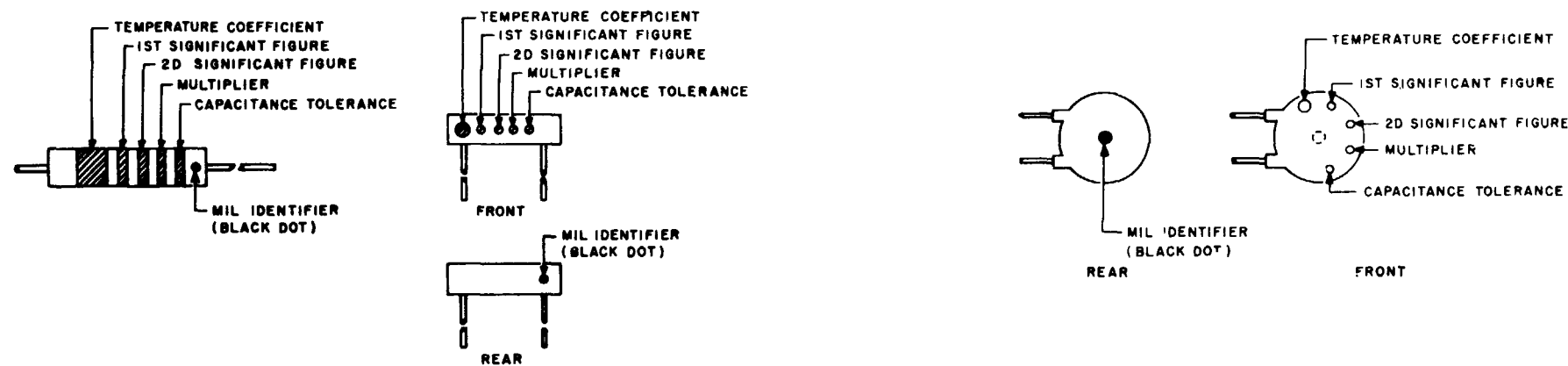

## COLOR CODE TABLES

TABLE I - For use with Group I, Styles CM, CN, CY and CB

COLOR	MIL ID	1st SIG FIG	2nd SIG FIG	MULTIPLIER <sup>1</sup>	CAPACITANCE TOLERANCE				CHARACTERISTIC <sup>2</sup>				DC WORKING VOLTAGE	OPERATING TEMP. RANGE	VIBRATION GRADE
					CM	CN	CY	CB	CM	CN	CY	CB	CM	CM	CM
BLACK	CM, CY, CB	0	0	1			± 20%	± 20%		A				-55° to +70°C	10-55 cps
BROWN		1	1	10					B	E					
RED		2	2	100	± 2%		± 2%	± 2%	C		C			-55° to +85°C	
ORANGE		3	3	1,000		± 30%			D			D	300		
YELLOW		4	4	10,000					E					-55° to +125°C	10-2,000 cps
GREEN		5	5		± 5%				F				500		
BLUE		6	6											-55° to +150°C	
PURPLE (VIOLET)		7	7												
GREY		8	8												
WHITE		9	9												
GOLD				0.1			± 5%	± 5%							
SILVER	CN				± 10%	± 10%	± 10%	± 10%							

TABLE II - For use with Group II, General Purpose, Style CK

COLOR	TEMP. RANGE AND VOLTAGE-TEMP. LIMITS <sup>3</sup>	1st SIG FIG	2nd SIG FIG	MULTIPLIER <sup>1</sup>	CAPACITANCE TOLERANCE	MIL ID
BLACK		0	0	1	± 20%	
BROWN	AW	1	1	10	± 10%	
RED	AX	2	2	100		
ORANGE	BX	3	3	1,000		
YELLOW	AY	4	4	10,000		CK
GREEN	CZ	5	5			
BLUE	BV	6	6			
PURPLE (VIOLET)		7	7			
GREY		8	8			
WHITE		9	9			
GOLD						
SILVER						

TABLE III - For use with Group III, Temperature Compensating, Style CC

COLOR	TEMPERATURE COEFFICIENT <sup>4</sup>	1st SIG FIG	2nd SIG FIG	MULTIPLIER <sup>1</sup>	CAPACITANCE TOLERANCE		MIL ID
					Capacitances over 10uuf	Capacitances 10uuf or less	
BLACK	0	0	0	1		± 2.0uuf	CC
BROWN	-30	1	1	10	± 1%		
RED	-80	2	2	100	± 2%	± 0.25uuf	
ORANGE	-150	3	3	1,000			
YELLOW	-220	4	4				
GREEN	-330	5	5		± 3%	± 0.5uuf	
BLUE	-470	6	6				
PURPLE (VIOLET)	-750	7	7				
GREY		8	8	0.01			
WHITE		9	9	0.1	± 10%		
GOLD	+100					± 1.0uuf	
SILVER							

- The multiplier is the number by which the two significant (SIG) figures are multiplied to obtain the capacitance in uuf.
- Letters indicate the Characteristics designated in applicable specifications: MIL-C-5, MIL-C-91, MIL-C-11272, and MIL-C-10950 respectively.
- Letters indicate the temperature range and voltage-temperature limits designated in MIL-C-11015.
- Temperature coefficient in parts per million per degree centigrade.

Figure 9-2. MIL-STD capacitor color code markings.

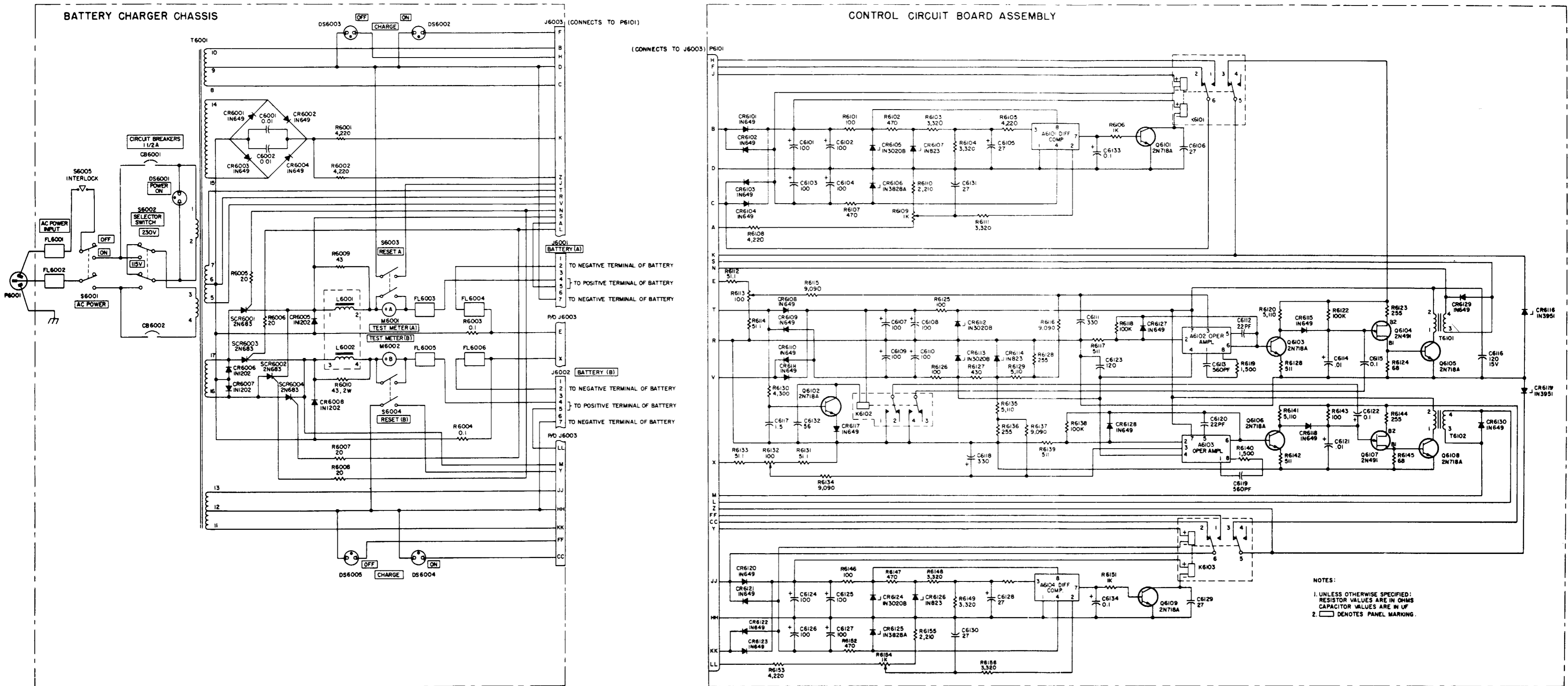

Figure 9-4. Battery charger, schematic diagram.

By Order of the Secretary of the Army:

HAROLD K. JOHNSON,  
*General, United State Army,*  
*Chief of Staff.*

Official:

KENNETH G. WICKHAM,  
*Major General, United States Army,*  
*The Adjutant General*

**Distribution:**

***Active Army:***

USASA (2)  
 CNGB (1)  
 Dir of Trans (1)  
 CofEngrs (1)  
 TSG (1)  
 CofSptS (1)  
 OCC-E (2)  
 USAMB (10)  
 USAARENBD (2)  
 USACDCCEA (1)  
 USACDCCEA:  
     Ft Huachuca (1)  
 USCONARC (2)  
 USAMC (2)  
 USAMICOM (2)  
 USAECOM (32)  
 ARADCOM (2)  
 ARADCOM Rgn (1)  
 OS Maj Comd (2)  
 USACDCEC (10)  
 USASTRATCOM (2)  
 USAESC (70)  
 USARV (5)  
 Armies (1)  
 Sig FLDMS (1)  
 USASCS (60)  
 USAESCS (10)  
 USACSS (30)  
 1st Log Comd (10)  
 9th Log Comd (10)  
 A Dep (1) except  
     LBAD (14)

SAAD (30)  
 TOAD (14)  
 LEAD (7)  
 NAAD (3)  
 SVAD (3)  
 ATAD (10)  
 Svc Colleges (1)  
 1st Cav Div (2)  
 Gen Dep (1)  
 Sig Sec Gen Dep (4)  
 Sig Dep (6)  
 USACRREL (2)  
 Ft Huachuca (5)  
 WSMR (5)  
 Ft Carson (7)  
 USAERDAA (2)  
 USAERDAW (2)  
 MAAG (2)  
 Mil Msn (2)  
 Sig FLDMS (PAC) (3)  
 Gen Dep (PAC) (5)  
 Sig Sec Gen Dep (PAC) (8)  
 Sig Dep (PAC) (12)  
 Units org under fol TOE:  
     (1 copy each)  
     11-155  
     11-157  
     11-158  
     11-587  
     11-592  
     11-597  
     29-134

**NG: State AG (3).**

**USAR: None.**

**For explanation of abbreviations used, see AR 320-50.**

RECOMMENDED CHANGES TO EQUIPMENT TECHNICAL PUBLICATIONS



THEN...JOT DOWN THE DOPE ABOUT IT ON THIS FORM. CAREFULLY TEAR IT OUT, FOLD IT AND DROP IT IN THE MAIL.

SOMETHING WRONG WITH PUBLICATION

FROM: (PRINT YOUR UNIT'S COMPLETE ADDRESS)

DATE SENT

PUBLICATION NUMBER

PUBLICATION DATE

PUBLICATION TITLE

BE EXACT PIN-POINT WHERE IT IS

PAGE NO.

PARA-GRAPH

FIGURE NO.

TABLE NO.

IN THIS SPACE, TELL WHAT IS WRONG AND WHAT SHOULD BE DONE ABOUT IT.

TEAR ALONG PERFORATED LINE

PRINTED NAME, GRADE OR TITLE AND TELEPHONE NUMBER

SIGN HERE

# The Metric System and Equivalents

## Linear Measure

1 centimeter = 10 millimeters = .39 inch  
 1 decimeter = 10 centimeters = 3.94 inches  
 1 meter = 10 decimeters = 39.37 inches  
 1 dekameter = 10 meters = 32.8 feet  
 1 hectometer = 10 dekameters = 328.08 feet  
 1 kilometer = 10 hectometers = 3,280.8 feet

## Weights

1 centigram = 10 milligrams = .15 grain  
 1 decigram = 10 centigrams = 1.54 grains  
 1 gram = 10 decigrams = .035 ounce  
 1 dekagram = 10 grams = .35 ounce  
 1 hectogram = 10 dekagrams = 3.52 ounces  
 1 kilogram = 10 hectograms = 2.2 pounds  
 1 quintal = 100 kilograms = 220.46 pounds  
 1 metric ton = 10 quintals = 1.1 short tons

## Liquid Measure

1 centiliter = 10 milliliters = .34 fl. ounce  
 1 deciliter = 10 centiliters = 3.38 fl. ounces  
 1 liter = 10 deciliters = 33.81 fl. ounces  
 1 dekaliter = 10 liters = 2.64 gallons  
 1 hectoliter = 10 dekaliters = 26.42 gallons  
 1 kiloliter = 10 hectoliters = 264.18 gallons

## Square Measure

1 sq. centimeter = 100 sq. millimeters = .155 sq. inch  
 1 sq. decimeter = 100 sq. centimeters = 15.5 sq. inches  
 1 sq. meter (centare) = 100 sq. decimeters = 10.76 sq. feet  
 1 sq. dekameter (are) = 100 sq. meters = 1,076.4 sq. feet  
 1 sq. hectometer (hectare) = 100 sq. dekameters = 2.47 acres  
 1 sq. kilometer = 100 sq. hectometers = .386 sq. mile

## Cubic Measure

1 cu. centimeter = 1000 cu. millimeters = .06 cu. inch  
 1 cu. decimeter = 1000 cu. centimeters = 61.02 cu. inches  
 1 cu. meter = 1000 cu. decimeters = 35.31 cu. feet

## Approximate Conversion Factors

To change	To	Multiply by	To change	To	Multiply by
inches	centimeters	2.540	ounce-inches	newton-meters	.007062
feet	meters	.305	centimeters	inches	.394
yards	meters	.914	meters	feet	3.280
miles	kilometers	1.609	meters	yards	1.094
square inches	square centimeters	6.451	kilometers	miles	.621
square feet	square meters	.093	square centimeters	square inches	.155
square yards	square meters	.836	square meters	square feet	10.764
square miles	square kilometers	2.590	square meters	square yards	1.196
acres	square hectometers	.405	square kilometers	square miles	.386
cubic feet	cubic meters	.028	square hectometers	acres	2.471
cubic yards	cubic meters	.765	cubic meters	cubic feet	35.315
fluid ounces	milliliters	29.573	cubic meters	cubic yards	1.308
pints	liters	.473	milliliters	fluid ounces	.034
quarts	liters	.946	liters	pints	2.113
gallons	liters	3.785	liters	quarts	1.057
ounces	grams	28.349	liters	gallons	.264
pounds	kilograms	.454	grams	ounces	.035
short tons	metric tons	.907	kilograms	pounds	2.205
pound-feet	newton-meters	1.356	metric tons	short tons	1.102
pound-inches	newton-meters	.11296			

## Temperature (Exact)

°F Fahrenheit temperature      5/9 (after subtracting 32)      Celsius temperature      °C

